

1. Camera Introduction	2
Device Overview.....	2
Status Indicator	3
2. Setup and Installation	3
Set up the Camera.....	3
Install the camera.....	7
3. View Your camera	8
Adjust Device list	8
Multiple Views.....	9
Live video.....	10
Manually Capture.....	11
Manually Record	12
Full Screen	12
2-Way Audio	13
Pan & tilt control.....	14
4. Alarm and Detection	15
Set up Motion detection and sensitivity.....	15
Set up Detection Area	16
Set up Noise Detection and Sensitivity.....	17
Set up Push notifications.....	18
5. Recording and Playback.....	20
Micro SD card Recording	20
Cloud storage service	22
Playback	24
Album	26
6. Camera settings	27
Camera Name	27
Share Arenti Devices with others.....	28
Device information	30
Installation Guide	31
Basic function	32
Network indicator.....	32

Privacy Protection.....	33
Screen Flip.....	34
Night Vision.....	35
Amazon Echo Show & Google Home	35
Advanced features-Onvif.....	36
Device version	37
Delete the Device	37
7. Use Arenti APP	38
Messages.....	38
Sharing History.....	39
Alarm Message.....	39
System Messages	39
Scene.....	40
Account	40
APP Settings.....	42
8. FAQ and Troubleshooting.....	45
FAQS	45
Troubleshooting	46

1. Camera Introduction

Device Overview

P2,P2T,P2F are indoor Pan & Tilt cameras that are compact and can be seamlessly integrated into your home. Loaded with smart features, they can do many things like rotate at your disposal to reach more areas. Or send you customized motion alerts. With unbeatable price, they make smart and high-quality home protection accessible to everyone.

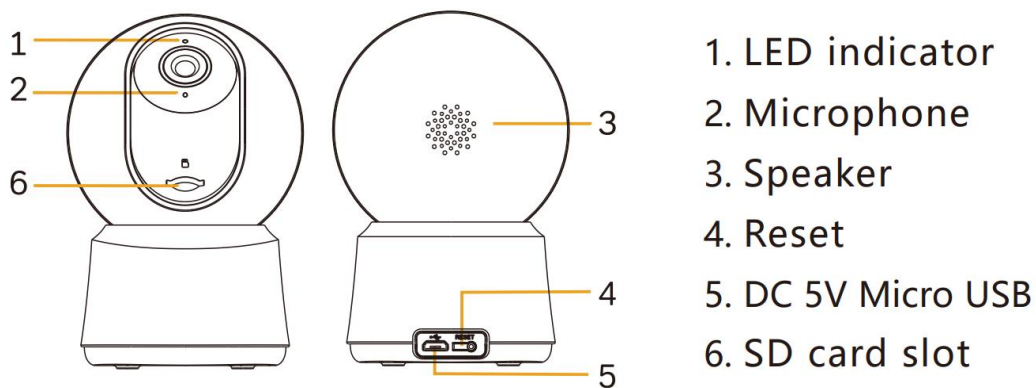

Status Indicator

Status Indicator	Camera status
Constant blue	Working properly/ WiFi Connection succeeded
Blue fast flashing	Upgrading
Red flashing slowly	Waiting to connect/ WiFi is not configured
Red flashing fast	Network abnormal/ WiFi connection failed

2. Setup and Installation

Set up the Camera

- What you'll need.

1. Wi-Fi and a working broadband internet connection with at least 2 Mbps upload speed.
2. A phone or tablet with iOS 8 or later or Android 4.2 or later
3. A power outlet

- Power on

Plug the power cable into the Micro-USB power port on the back of the camera, the camera will automatically turn on, wait for the 30s, the indicator light will flash red slowly means boot up is finished.

Tip: Do not move the lens of the camera to force it to rotate after turning it on.

Connect Arenti APP

Scan QR code to download and install the Arenti APP. Also, you can search 'Arenti on App Store (IOS); Play Store(Android). Download and install Arenti APP. Register and log in.



Open the Arenti APP home page, Click '+' at the right top page. Follow the guide on the APP to add the camera.

1. Choose P2 camera on APP and power on the P2 camera

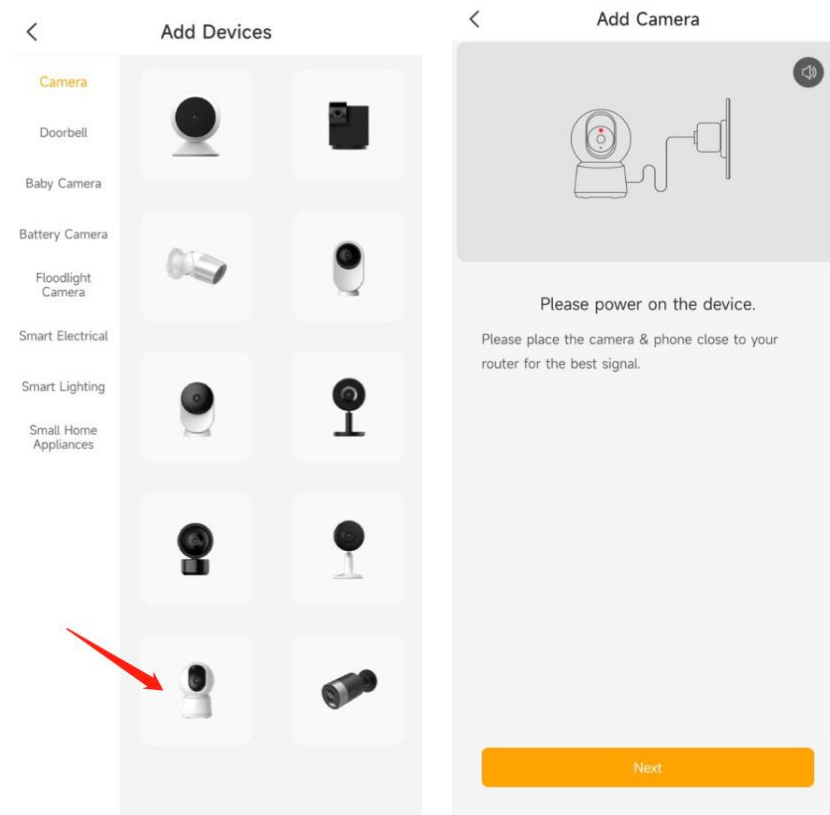

2. Waiting camera boot up around 30s. **Make sure the network indicator red flashing slowly and enable it** . If not please reset the camera, then wait the network indicator red flashing slowly. Then tap 'Next'.

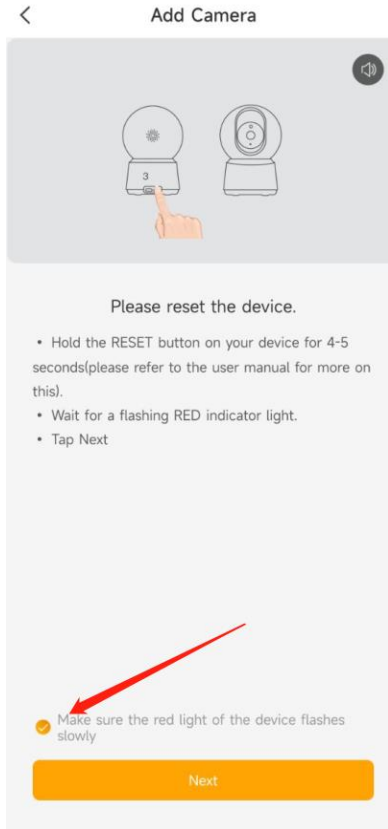

3. Select the wifi you want camera to connect, and input the correct Password. Tap 'Next'.
Note: P2 only support the 2.4GHz wifi.

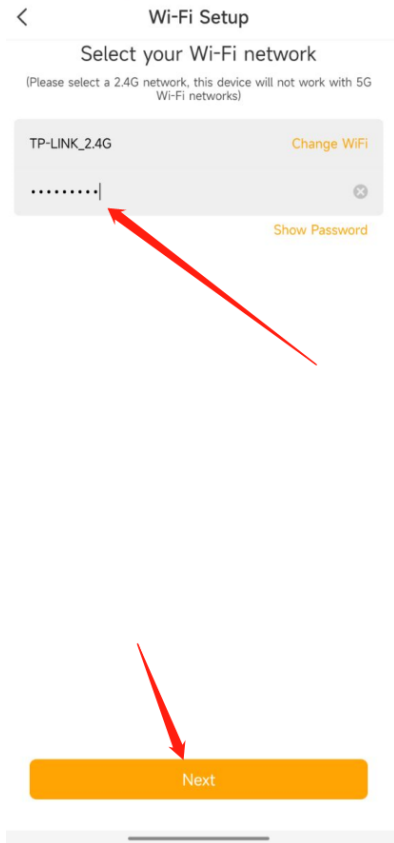

- APP will generate the QR code for camera to scan. Keep your phone 5-8 inches(15-25cm) from the lens . **Please scan the QR code when indicator in red flashing slowly.**
- A tone will be heard when successfully scanned. Then tap 'Notification tone heard'
After reading QR code, camera get the WiFi information(name/password) from APP QR code, and start to connect the WiFi. **The network indicator will turn to red fast flashing.**

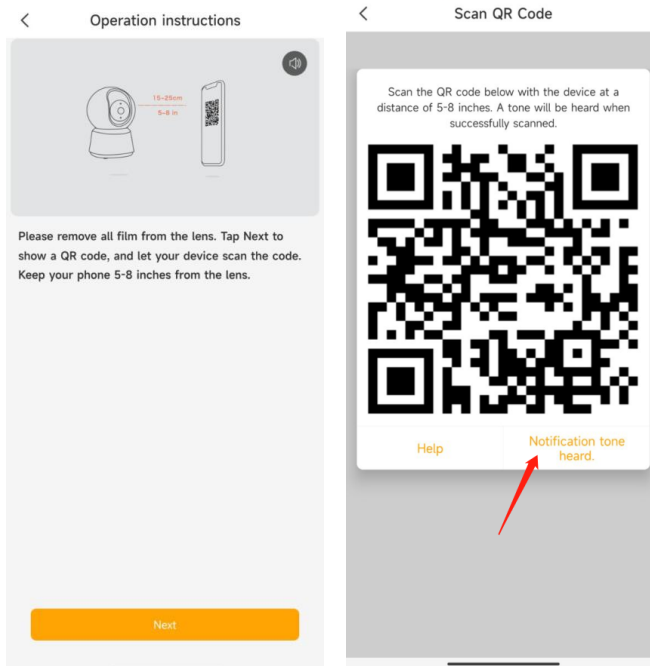

- Around 30s later, **the camera indicator turns to constant blue, means camera connect the WiFi.** And APP will find the device and add it to APP. Tap 'Done' to finish the process.

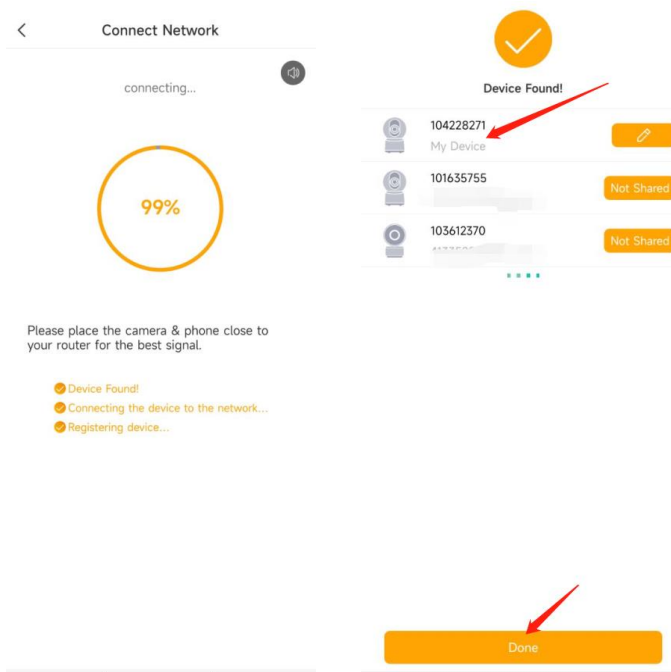

Note: When adding the camera, ensure the WIFI network is good, the camera is normally turned on, and the indicator light flashes red slowly. After the connection is successful, the indicator light is solid blue.

Install the camera

You can put the camera on a flat surface or mount it on the wall.

Mount on the wall:

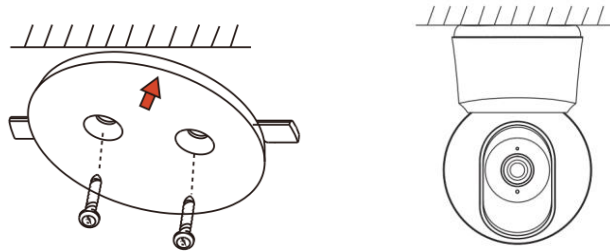

Installation Precautions:

1. The installation wall needs to be able to bear at least 3 times the total weight of the camera.
2. To prevent injury, the unit must be securely fastened to the ceiling or wall by the installation instructions

3.View Your camera

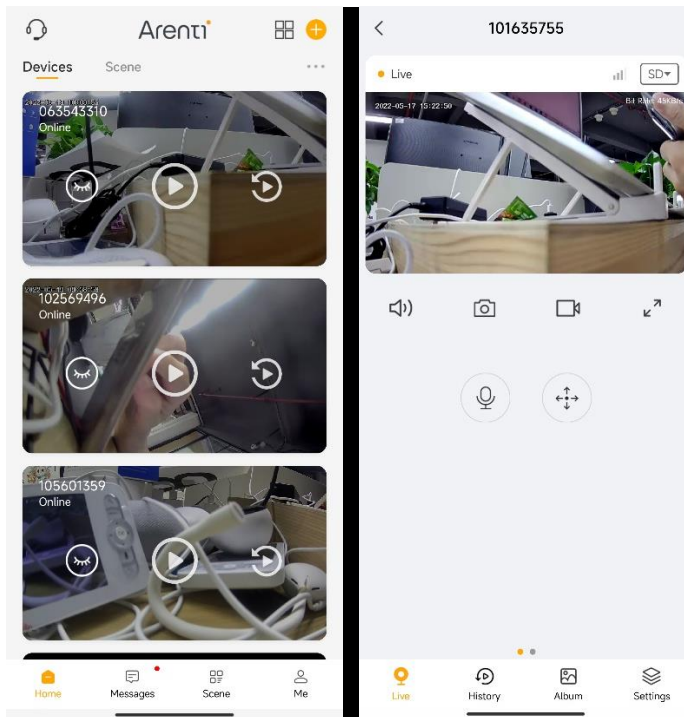

	Home page privacy		Multiple views
	Play Camera Live video		Play camera history video
	Get technical support		Add new device
	Video audio ON/OFF		Manually capture, the image will save to the album
	Full screen mode		Manually record, the recording will save to the album
	Device Wi-Fi signal		Sub-stream mode
	Press to talk(2-way audio)		Main-stream mode
	Current network bit rate		Pan & tilt control

Adjust Device list

You can just the list view (List/Grid) and sequence of your device.

List View

Tap the icon, you will see Sort , tap the List view ,the device will be the simple

camera icon in list. Tap the Sort to adjust the device sequence.

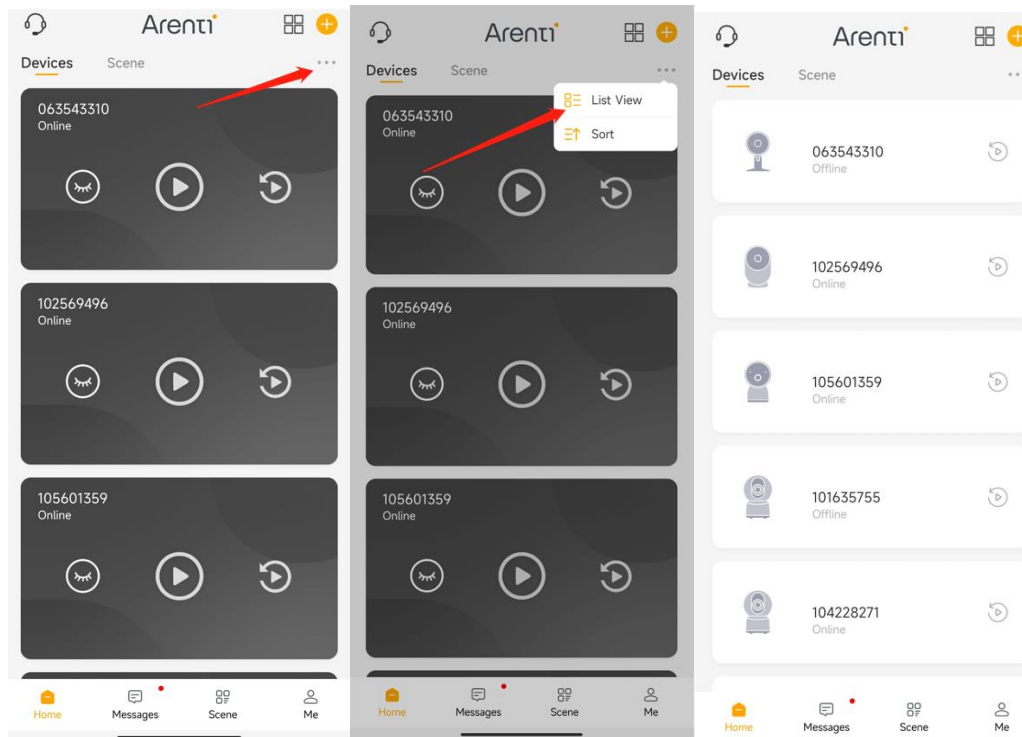

Press and hold to move the camera to the sequence you need. Then tap Done ,back to the device list.

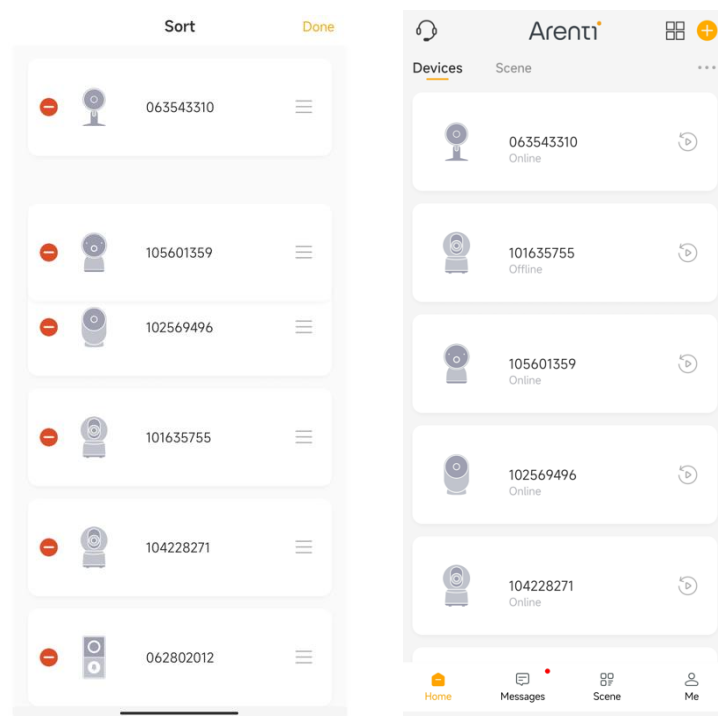

Multiple Views

If you have 2 or more cameras added in your Arenti App, you can view multiple streams at the same time.

Tap  icon , the first 4 cameras will show in one screen. You can slide the screen to check next 4 camera.

You can choose camera to 2-way audio, Manual capture, record.

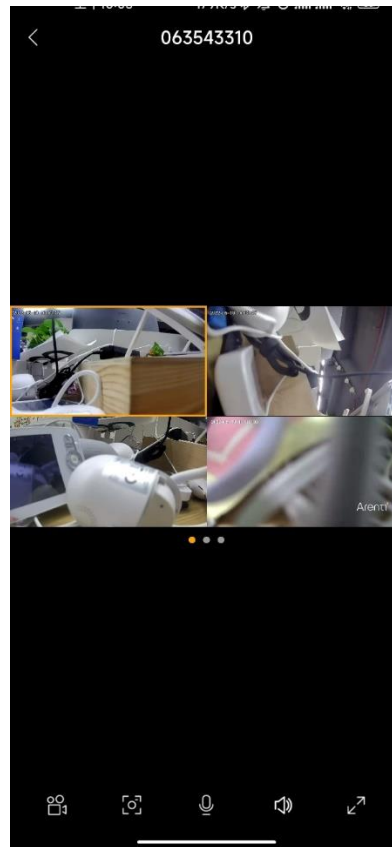
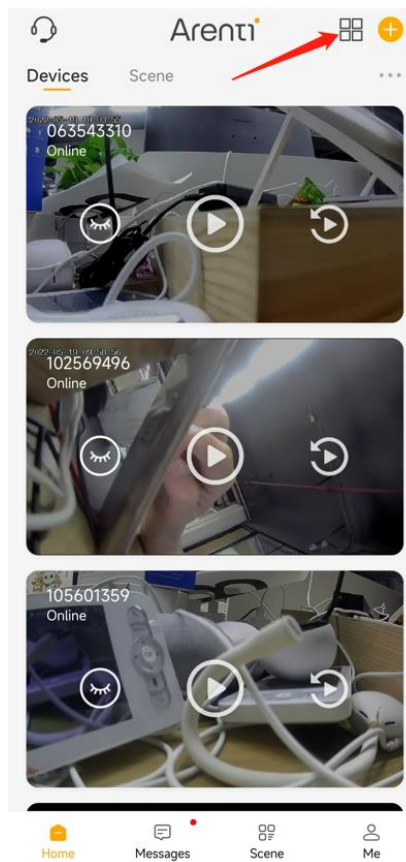

Live video

Tap  icon to view the camera Live video. Tap the SD to choose SD/HD/FHD different resolution.

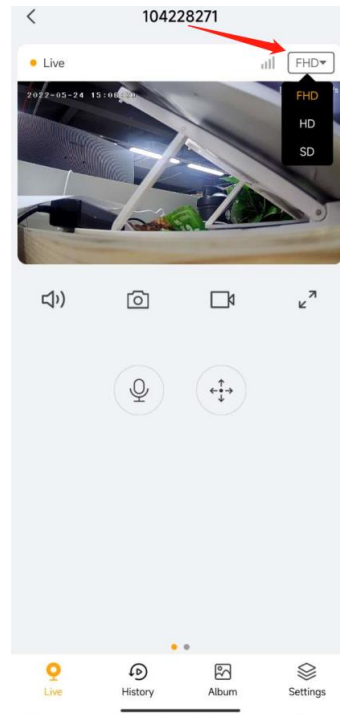
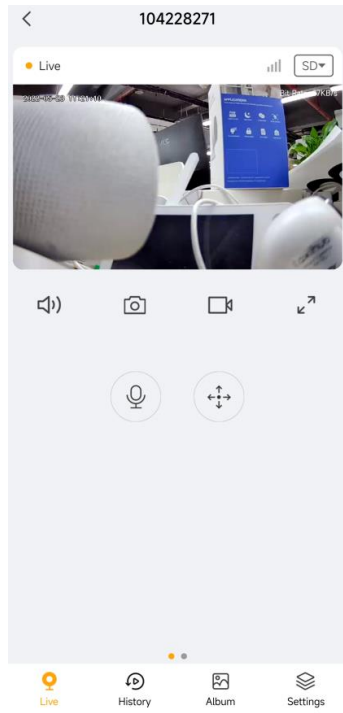

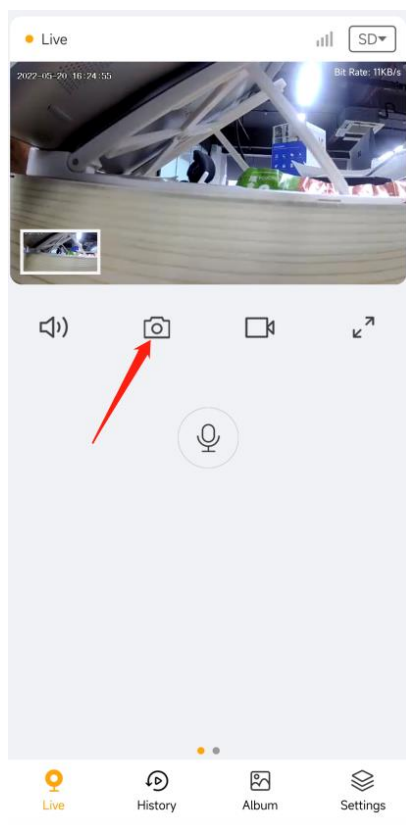

Manually Capture

Tap  icon to capture the image. Image will save in Album.



Manually Record

Tap  icon to start record the video, tap  to stop the record, the record will save in Album.

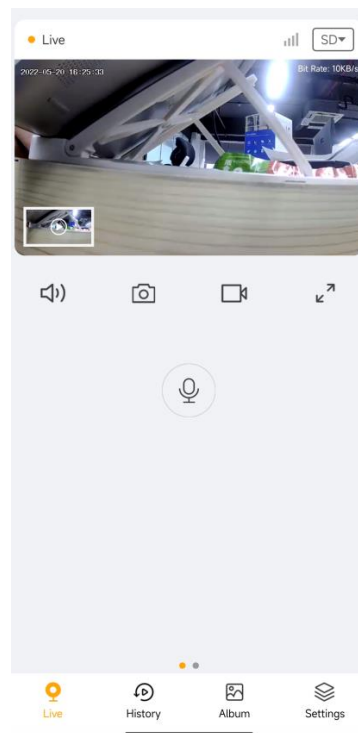
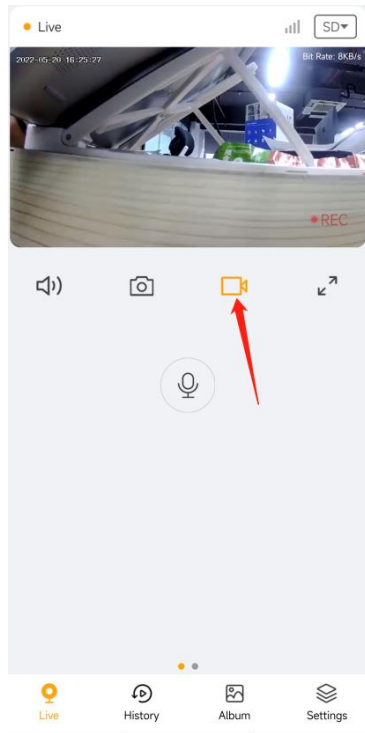

Full Screen

Tap  icon to check the video in full screen.

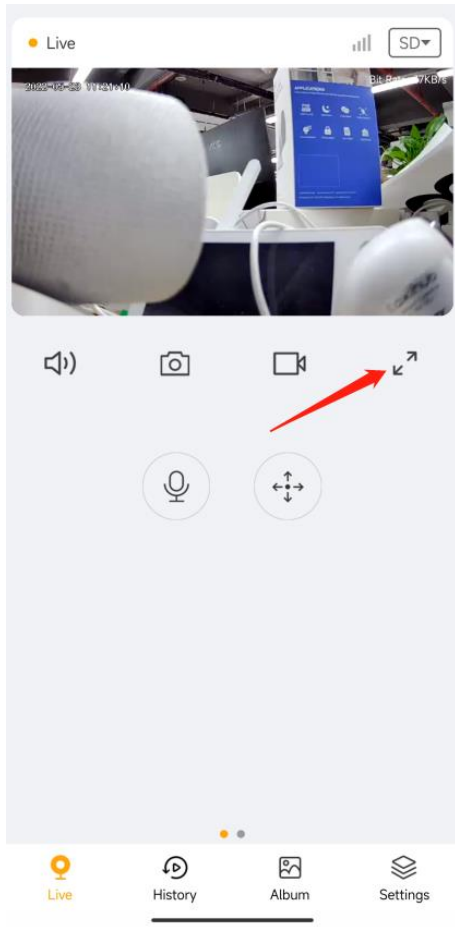

2-Way Audio

Tap/Press the  icon to talk.

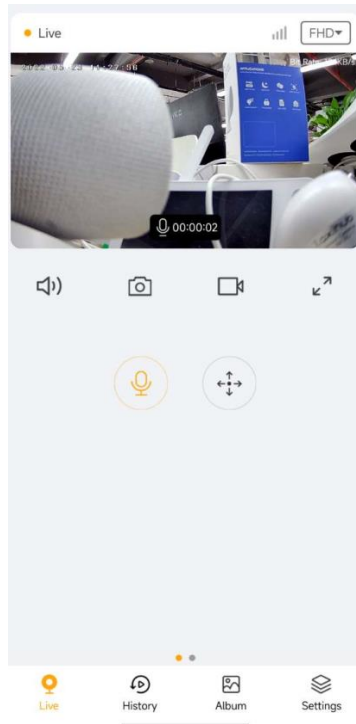
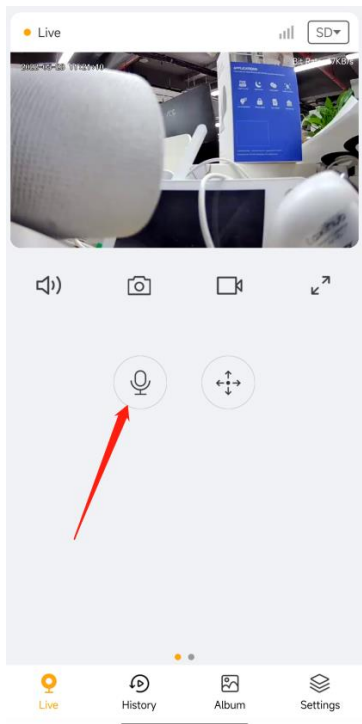

Pan & tilt control

Tap  icon to enter Pan & tilt control page.

Tap/press the direction to remote the camera Pan & tilt

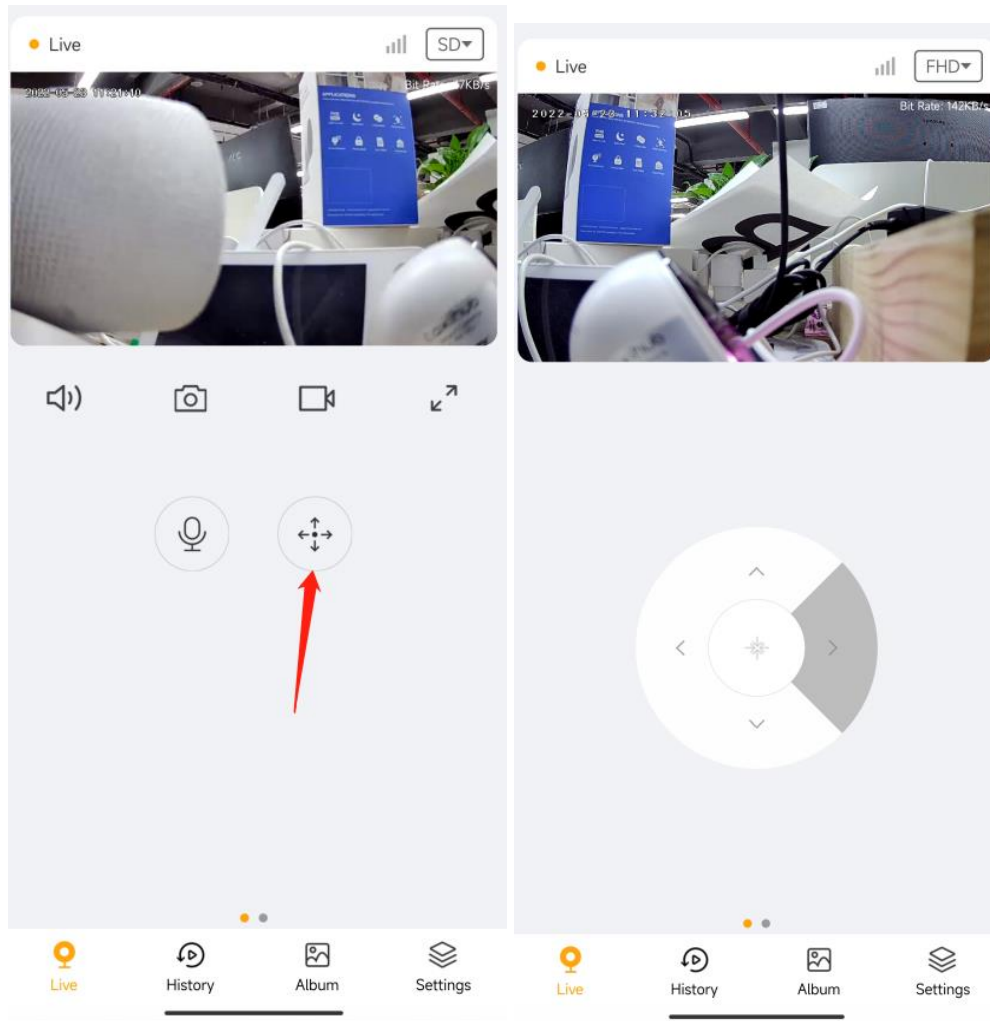

4. Alarm and Detection

About Motion Detection

Arenti camera determines whether each macroblock has moved by dividing the grid. When the number of moved blocks reaches a certain proportion of the number of armed blocks, the alarm will start. The working principle of motion detection is that camera will judge it as motion when differences in 2 frames reach 0.5%-10% (customize by adjusting motion sensitivity) of the image. When the picture changes, the number calculated and compared will exceed the threshold and instruct the system to automatically make corresponding process.

Set up Motion detection and sensitivity

Go to camera live video page- Settings-Alert Settings-Motion detection-On
And you can choose and set the motion detection sensitivity.

Note: High-The most sensitive Level, It will detect more motions.

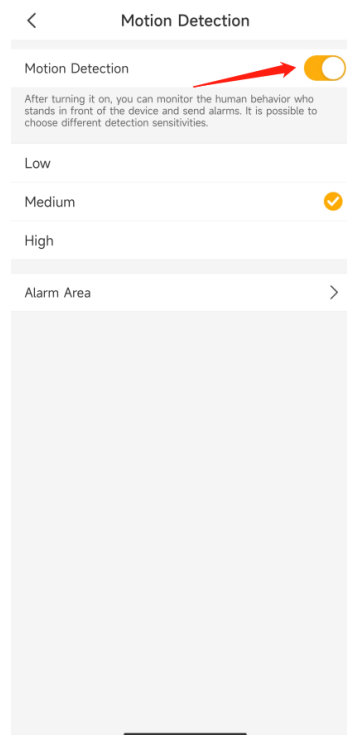
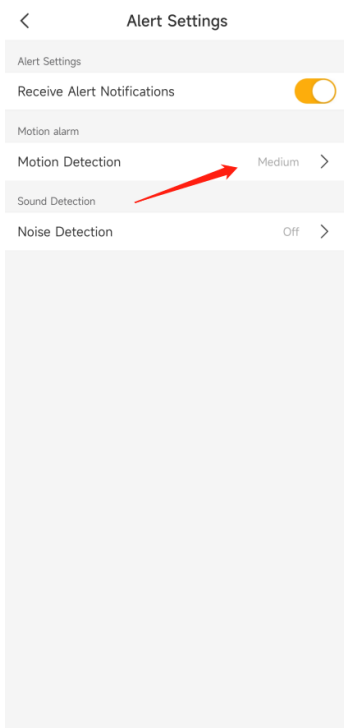
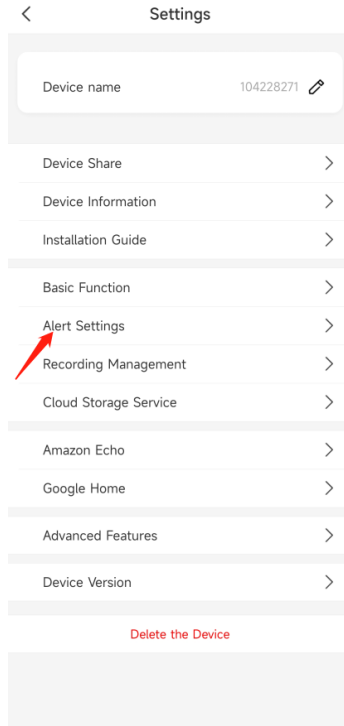
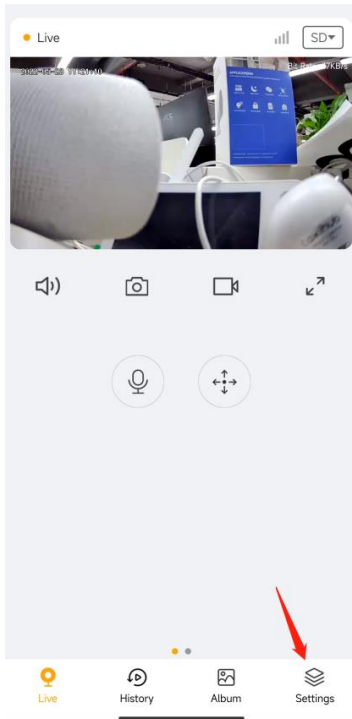

Set up Detection Area

Go to camera live video page- Settings-Alert Settings-Motion detection-Alarm Area

Tap the  icon to choose the area you want to detect.

Tap the  icon to erase to yellow area that you don't want to detect.

Tap 'Save' to save the Detection area settings.

Note: Camera will only detect the motion in yellow area.

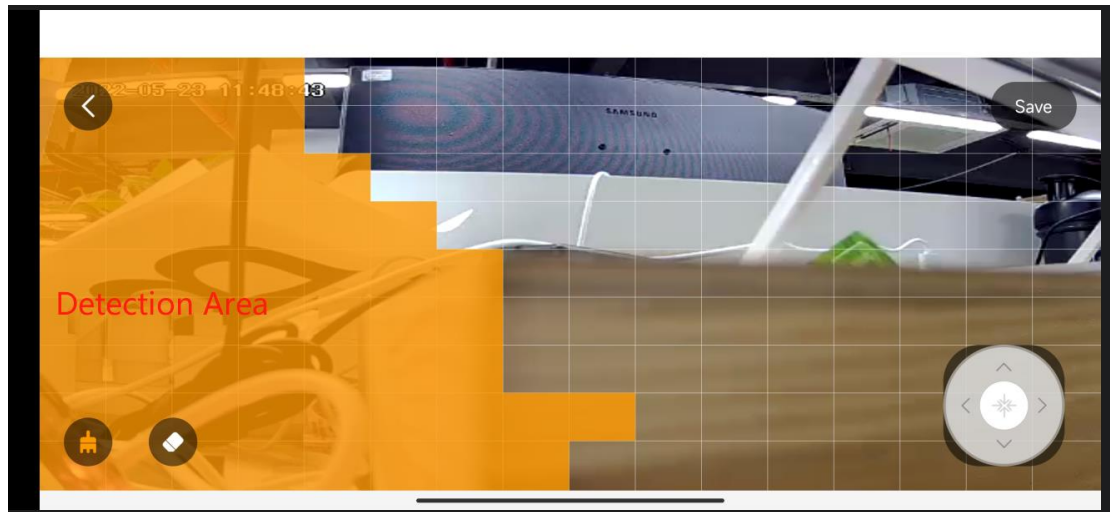

Set up Noise Detection and Sensitivity

Go to camera live video page- Settings-Alert Settings-Noise detection-On
And you can choose and set the noise detection sensitivity.

Note: High-The most sensitive Level.

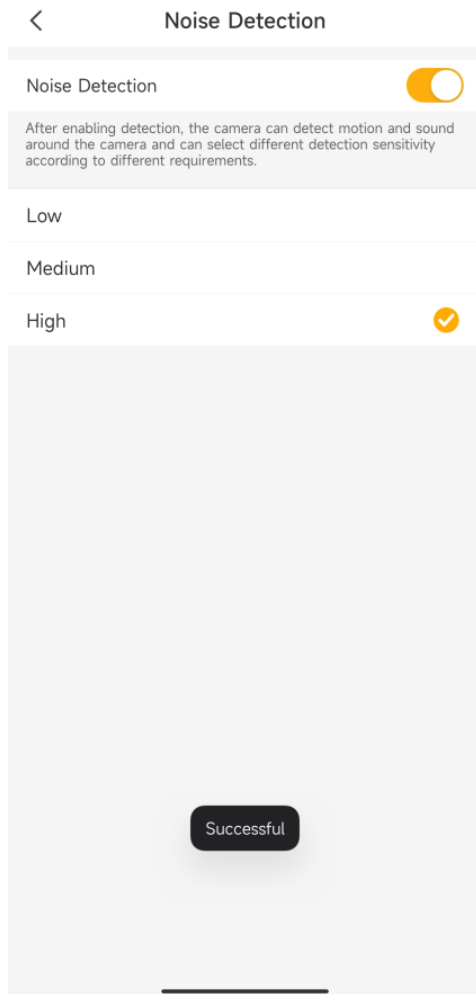

Set up Push notifications

1. Go to camera live video page- Settings-Alert Settings-Receive Alert Notifications:
Enable

Your mobile phone will receive the Alarm notification when camera detect the motion/noise.

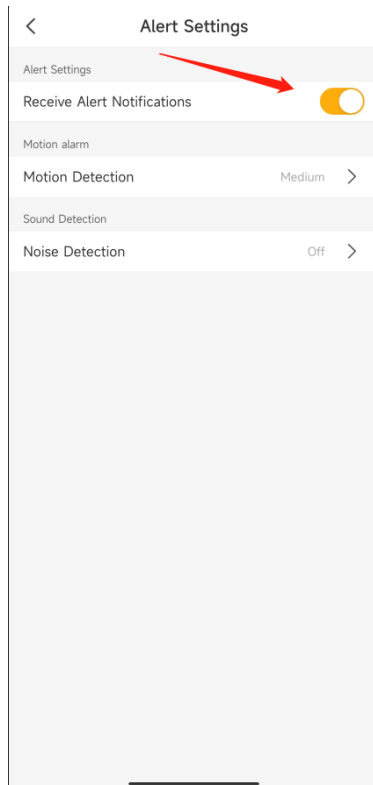

2. Set your phone to allow Arenti App to send push notifications. Go to your phone Settings, find Notifications and among the App list find the Arenti App. Make sure the mobile phone allow the Arenti App send notifications.
Mobile phone-Settings-Notifications-APP notifications-Arenti APP

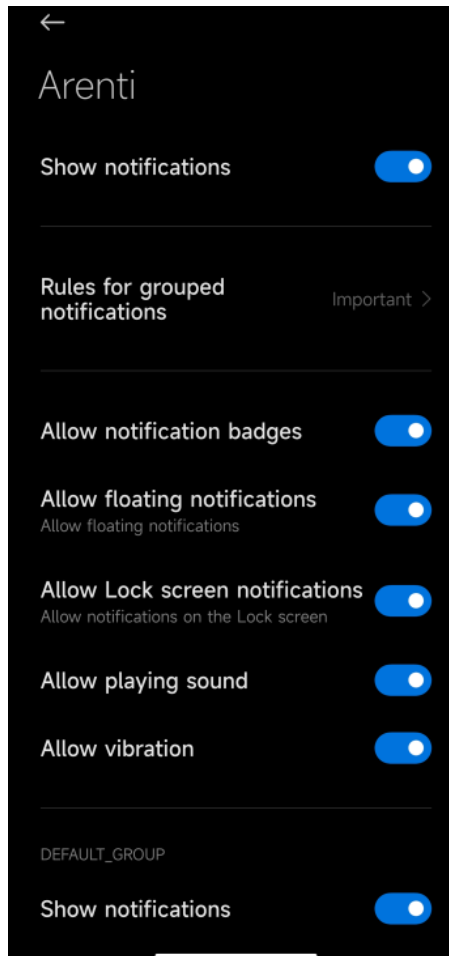

5. Recording and Playback

Micro SD card Recording

With an Micro SD card inserted the camera can save motion alarm recordings or continuous recordings to the Micro SD card.

Choose a suitable SD card

1. Recommend SD card spec: Class 10 and above, Format FAT32, 2G-128G, brand Micro SD Card
2. Choose the SD Card Capacity
Example : 32GB SD card with 1080P camera
Full-Day recording: around 4 days
Event recording (3min for one event,20events per day):around 4 months
Note: When full,Camera will overwrite the oldest recordings.

Insert the Micro SD card

Move the camera Lens up push the Micro SD card in until it's locked or you hear a 'Click

'sound.

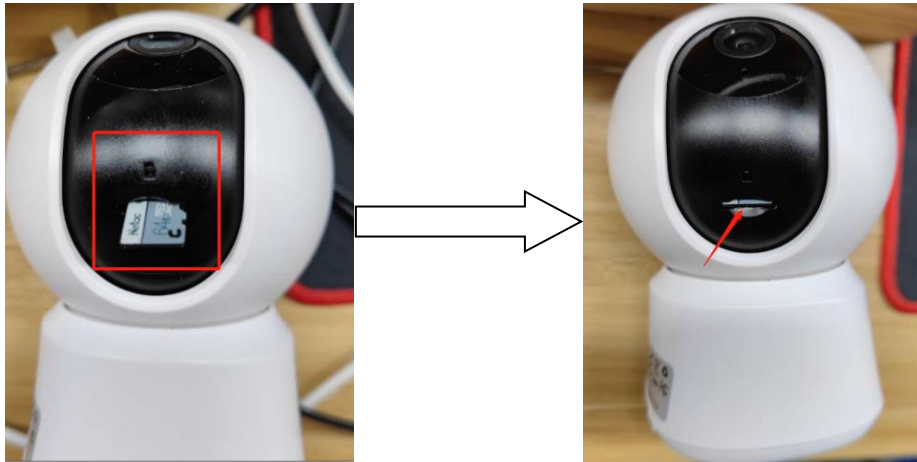

Set Recording(Micro SD card)

1. Event recording: Arenti APP-Device(tap device to live video page)-Settings-Recording Management- Event recording-Choose the Recording time-1/2/3 minutes

Note: It will only record the motion alarm recordings to the SD card. Each event recordings 1/2/3 minutes

2. Full day recording: Arenti APP-Device(tap device to live video page)-Settings-Recording Management-Full-Day Recording

Note: Camera will save continuous recordings to the SD card.

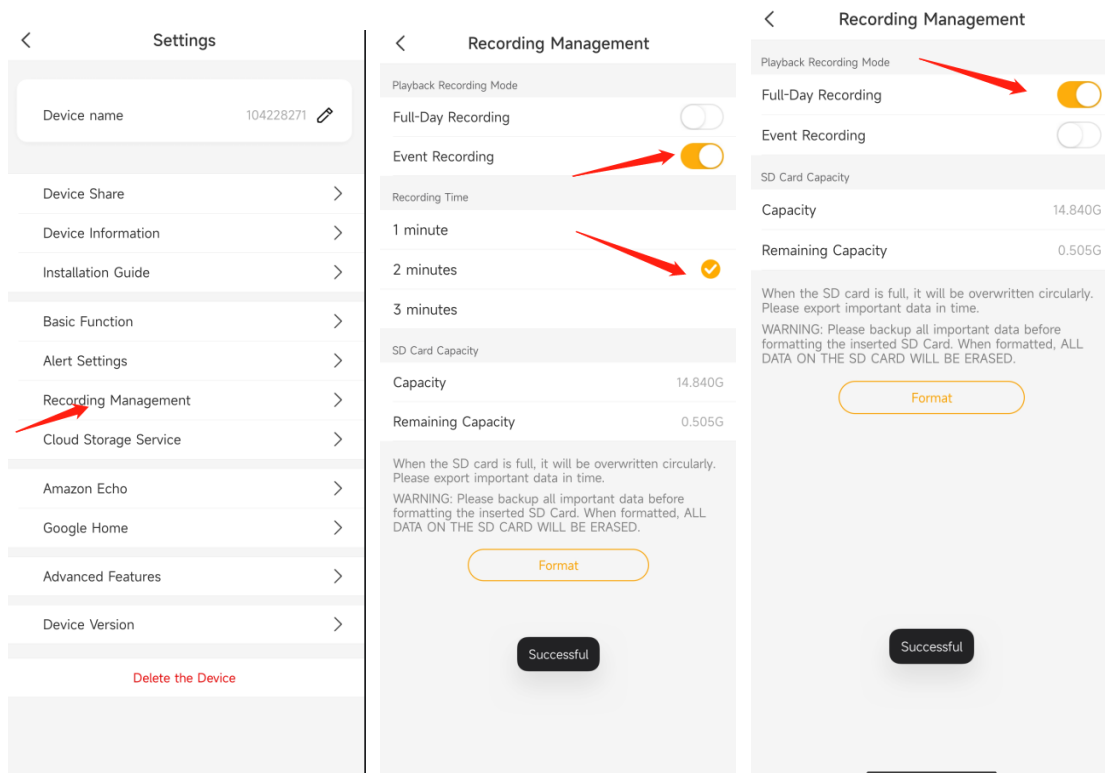

SD Card Capacity

After you insert the properly SD card, You can check the SD card Capacity/Remaining

Capacity information.

Support to Format the SD card by APP. After format the SD card, all data will be clear in SD card.

Cloud storage service

Arenti will give away 3 months free event cloud storage service for each camera. Each device needs its own plan, Cloud Storage Service Fee will be charged per device.

Note: the rules may change in the future

Activate Cloud storage service

1. Activate the free cloud storage service

Arenti APP-Device(Tap device to live video page)-Settings-Cloud Storage Service-Try 3 months for free

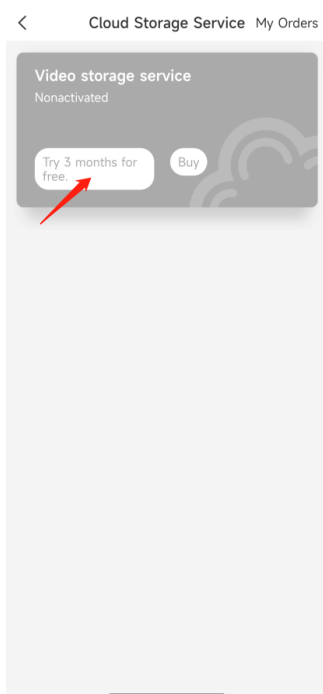

2. End free trial event cloud storage service

Arenti APP-Device(Tap device to live video page)-Settings-Cloud Storage Service-End trial

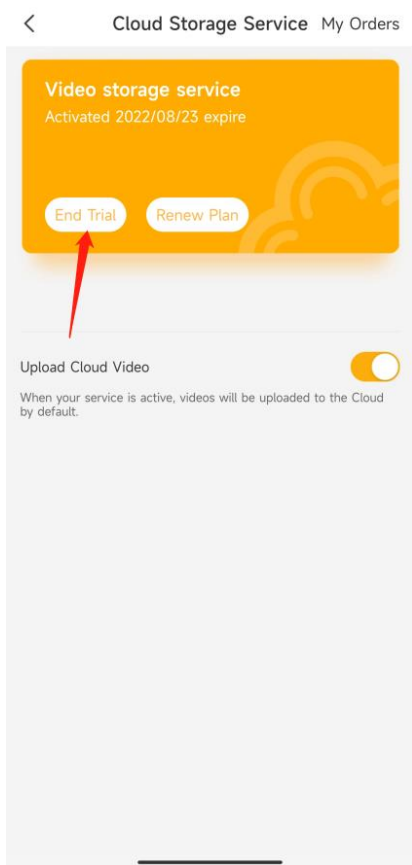

3. Buy/renew the event cloud storage service plan

Tap Buy/Renew Plan icon to order the cloud storage service for your device.

Set recording-Cloud storage

1. **Event recording:** You can use the free trial or buy/renew the event cloud storage service plan to save the motion alarm recordings to the cloud storage
2. **Full day recordings:** You can buy/renew the event cloud storage service plan to save the Continuous recordings to the cloud storage
Note: Please end trial the free event cloud storage service first, then camera will start the service that you bought.

Stop Uploading

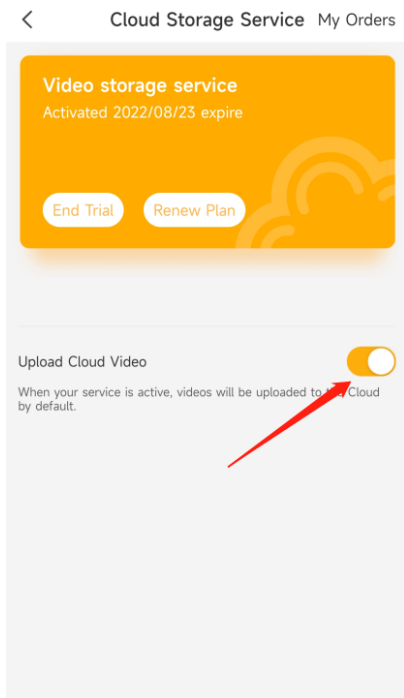

You can disable the Upload icon, to stop the camera uploading the video to cloud storage service. There will be no recordings on cloud storage.

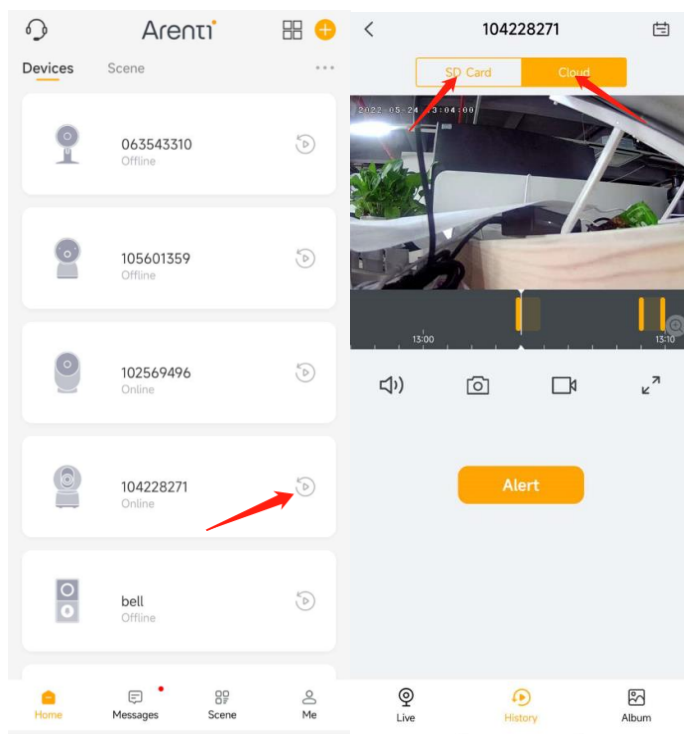

Playback

1. Tap the  icon to check the history video. According your own plan choose SD card or Cloud to playback.



2. Tap  icon to select a date to search the recordings. Tap the  icon to scale timeline and slide to find the

recordings you want to replay, waiting for loading and it'll automatically start to play.

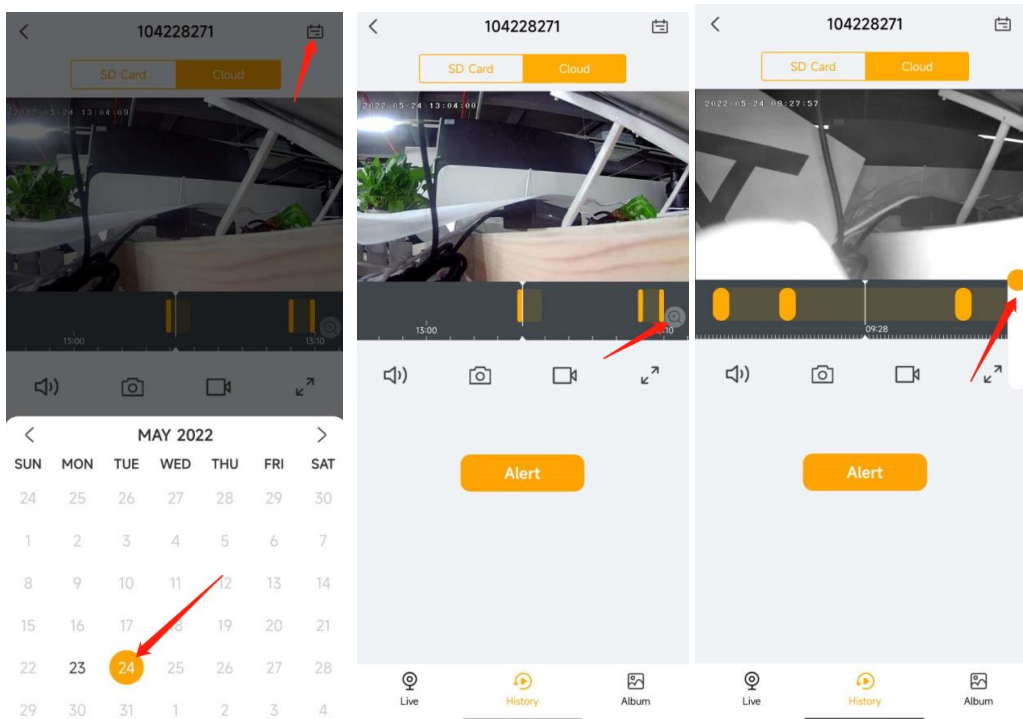

3. Tap 'Alarm' to search and play alarm recordings.

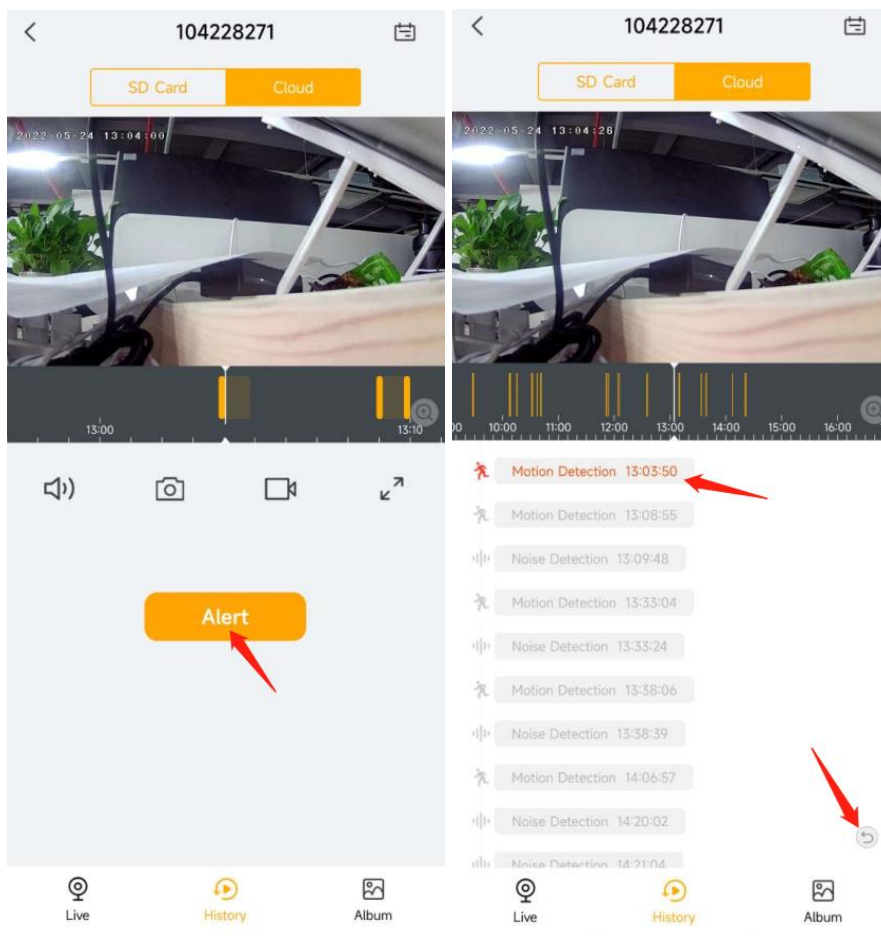

4. Playback from the Alarm messages.

Go to Messages-Alarm messages-Device, choose the messages, tap  icon to play the recording.

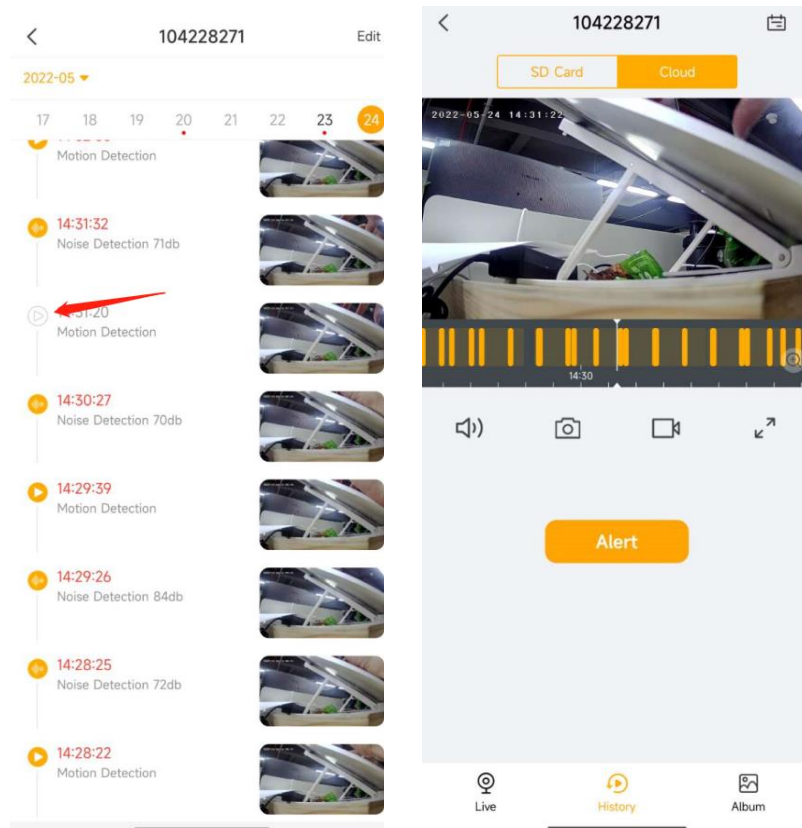

Album

You can browser all picture/video that captured manually in album. Also you can share the video/picture in album.

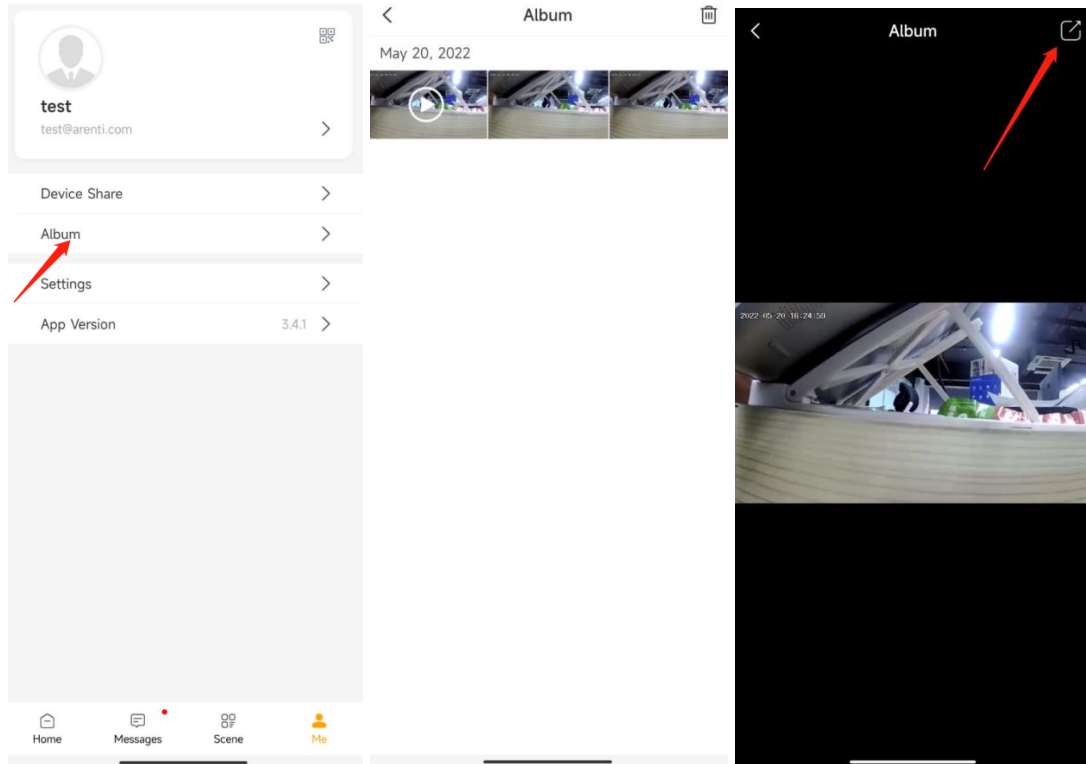

6.Camera settings

Camera Name

You can rename the camera

Arenti APP-Device(Tap device to live video page)-Settings-Device name,after you input the new name,tap OK to save.

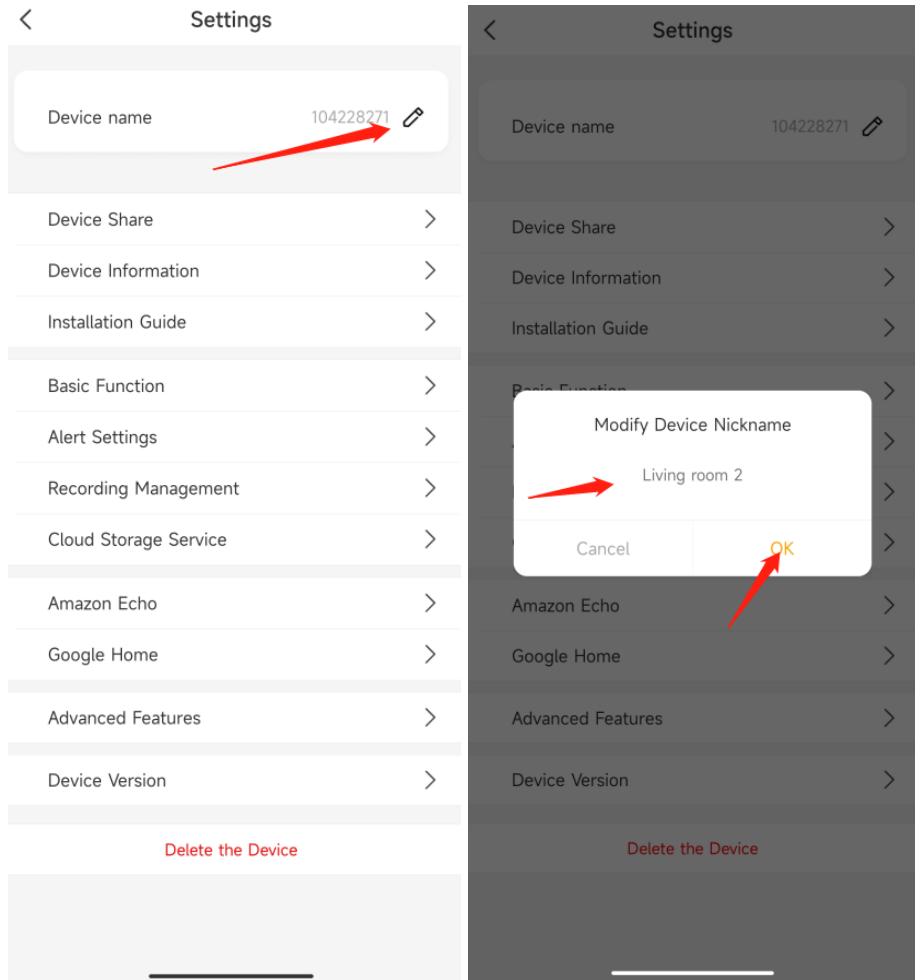

Share Arenti Devices with others

1. Arenti APP-Device (Tap device to live video page)-Settings-Device Share-Add-Share the Qrcode

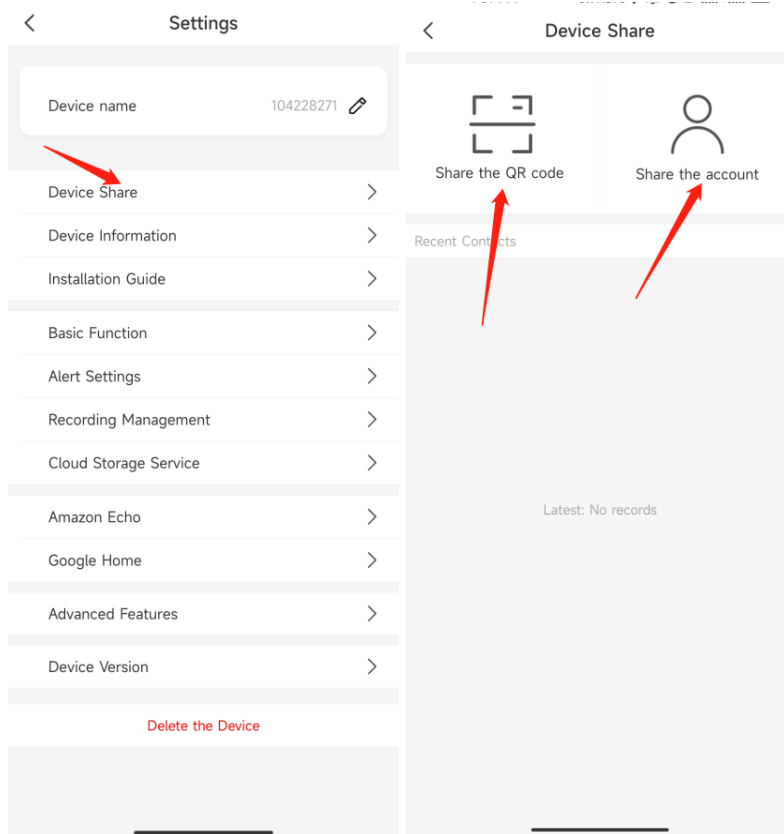

2. Launch the Arenti APP in another mobile phone and tap Me-Qrcode. Scan the Qrcode to share the device.
Also you can manually input the user account to share the device. And accept the shared device on another mobile phone.

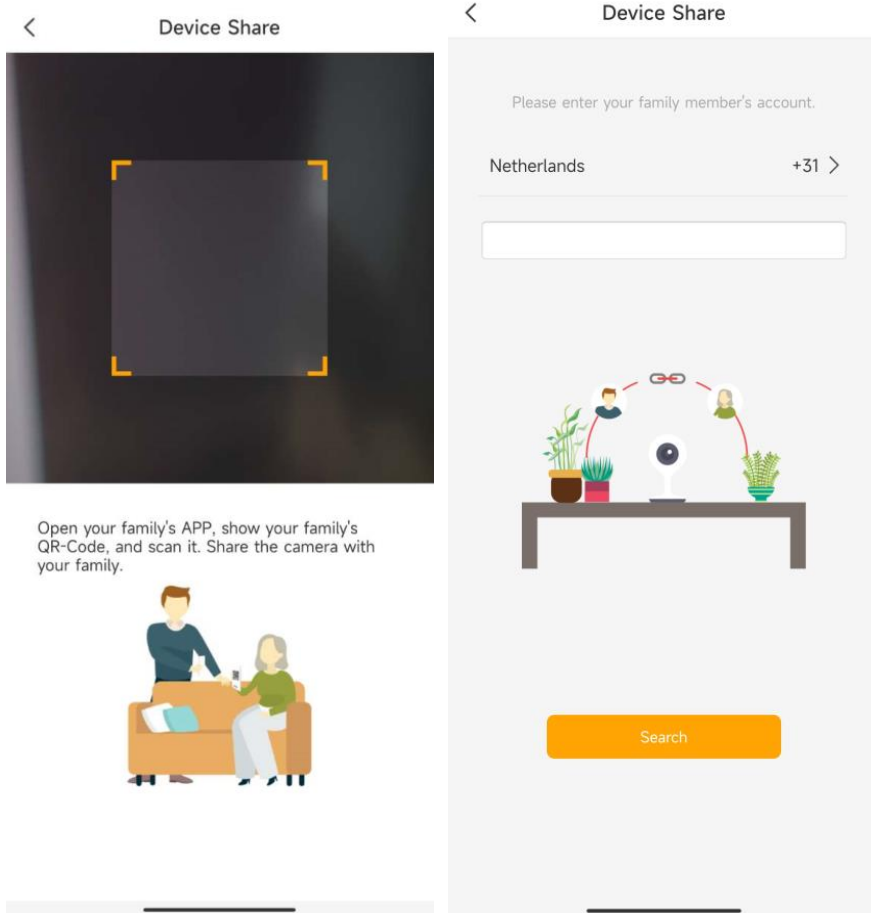

Note: needs your friends create the account (same country) and login the Arenti APP also. Your friends account could access the Live video, recordings in SD card(not allowed via cloud storage)

Device information

You can check the camera information from: Arenti APP-Device (Tap device to live video page)-Settings-Device information: Network Name, Signal Strength, Virtual ID,IP, Mac Address, Time zone.

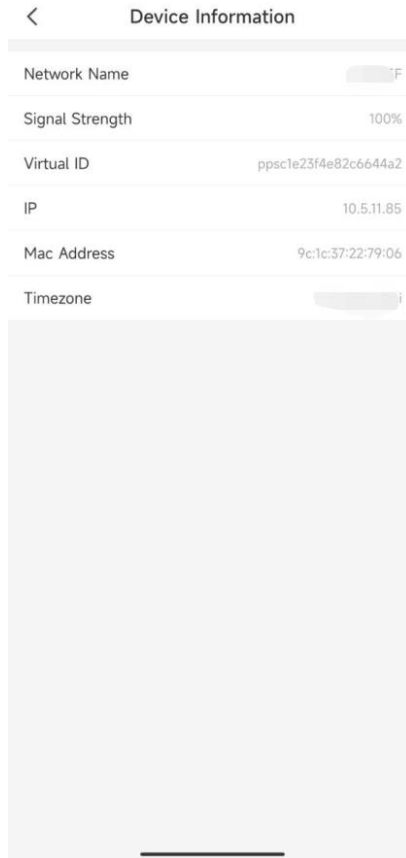
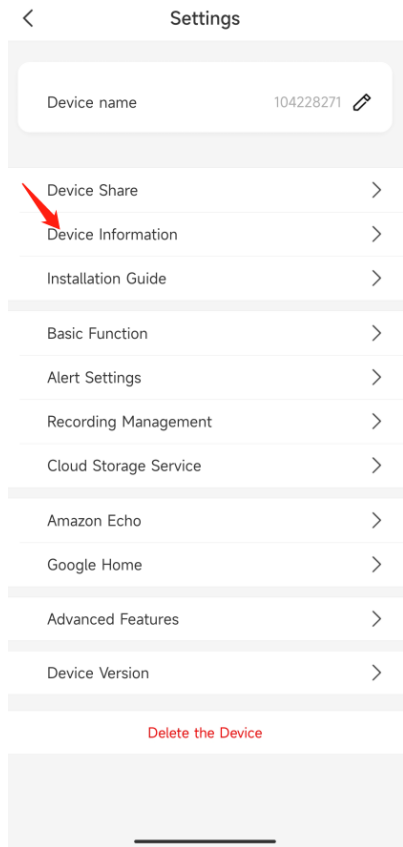

Installation Guide

Check from: Arenti APP-Device (Tap device to live video page)-Settings-Device information
APP will guide you to install the camera in a good wifi position, to keep camera working properly.

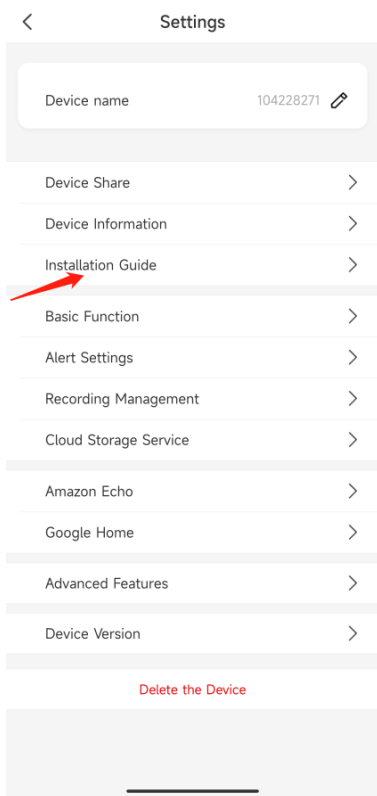

Basic function

Network indicator

You can turn off the blue network indicator by: Arenti APP-Device(tap device to live video page)-Settings-Basic Function-Network Indicator: Disable

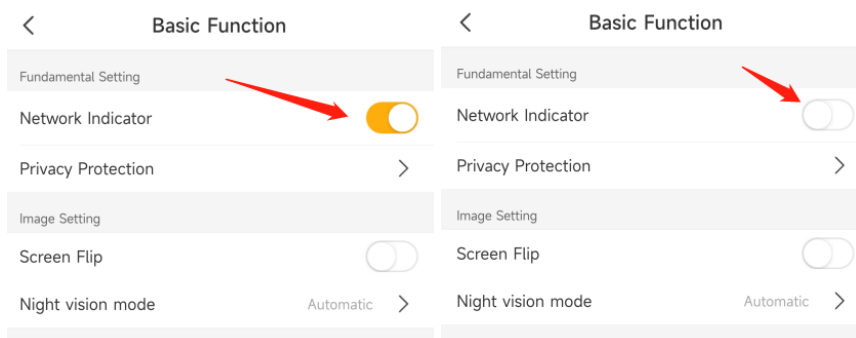



Privacy Protection

Turn On/Off Camera Lens

Turn off the camera: APP-Device(tap device to live video page)-Settings-Basic Function-Privacy Protection-Lens OFF

The Lens will move up and be covered automatically, the camera will stop Live video and stop recording .

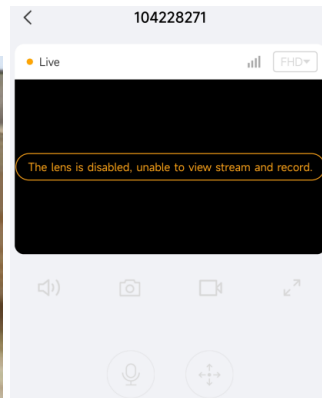
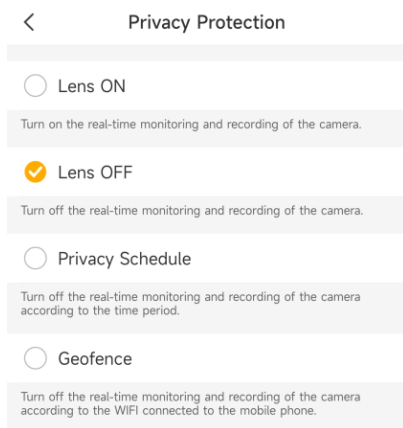

Privacy Schedule

You can set the time period to turn off the camera Lens.

< **Set the Time Period** ✓

Set the Start & End time for your privacy mode period, when the camera will NOT record any footage.

Start Time 00:00

End Time 00:00

Select Day

Mon

Tue

Wed

Thu

Fri

Sat

Sun

Screen Flip

If you mount camera on the wall, and the image needs to be flip. You can enable: Screen Flip to flip the image.

< **Basic Function**

Fundamental Setting

Network Indicator

Privacy Protection >

Image Setting

Screen Flip →

Night vision mode Automatic >

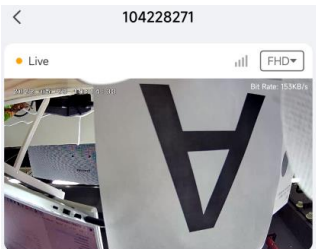
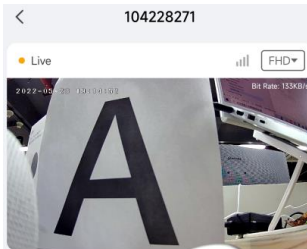
Night Vision

Set the camera's color mode during different times of the day and night.

Automatic: The camera will automatically switch between Color and Black & White modes according to the light conditions.

OFF: The camera will capture color images that usually appear during the day.

On: The camera will capture black-and-white images that usually appear during the night with the IR LEDs on.

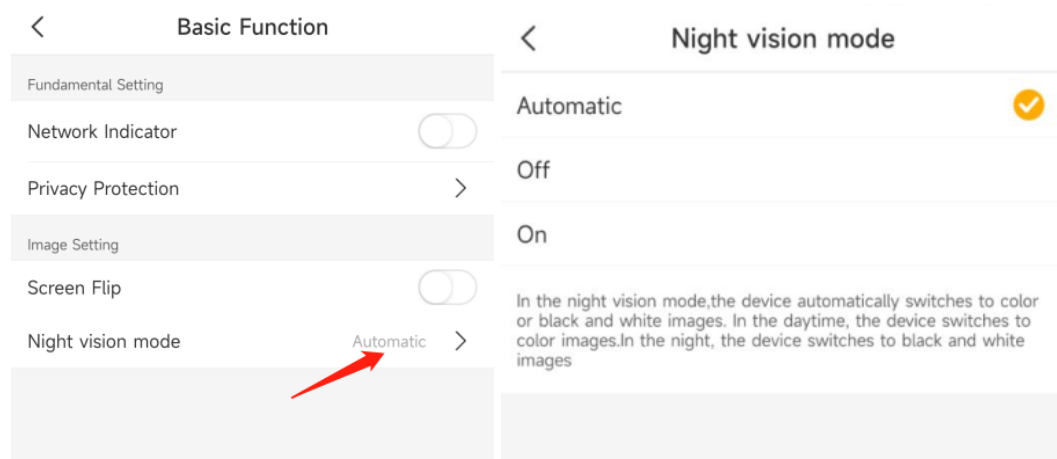

Amazon Echo Show & Google Home

Tap Amazon Echo/Google home to learn how to bind camera.

After bind, you can check the camera Live video on Amazon Device and Google Home device.

Note:

1. User name is the account name (email address/phone number) in Arenti APP and it is case sensitive. Need use lower case.
2. Please do not use the auto-filling, input the information manually.
3. Please select the country
4. If login failed, please re-start the Alexa APP and enable the skill again.

Instructions:

Amazon Echo: <https://www.youtube.com/watch?v=fUzPfG7zlm4>

Google Home: <https://www.youtube.com/watch?v=2Bt3xIAGsh4>

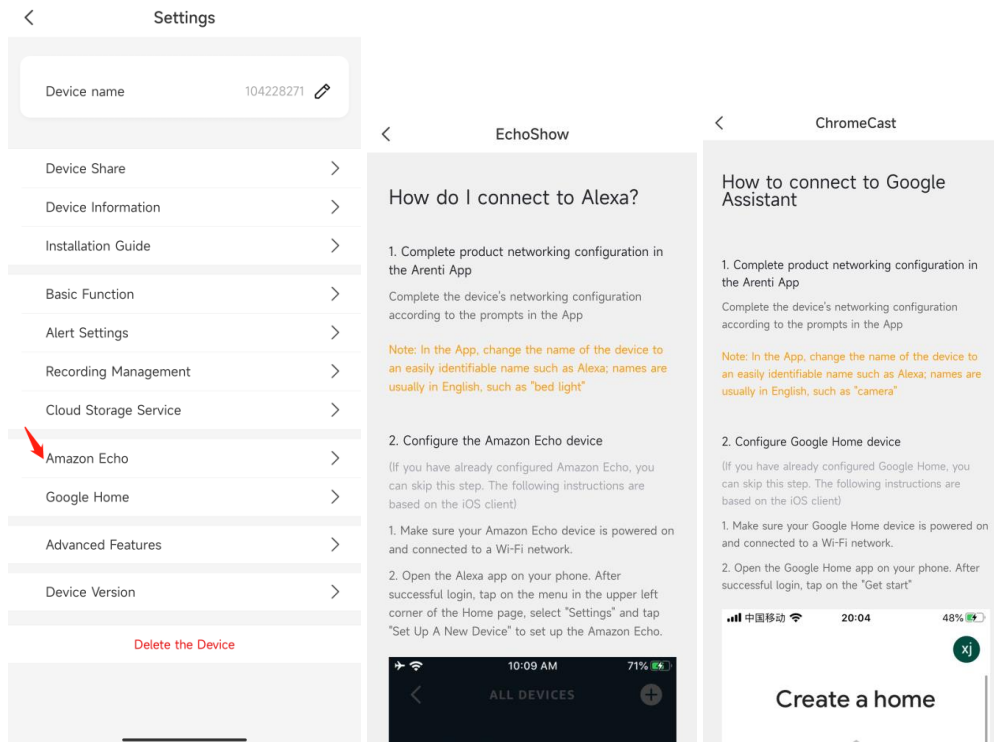

Advanced features-Onvif

Tap Advanced Features-Onvif settings-enable ;set password and submit.

You will see the camera LAN IP address.

Onvif Port:8000 RTSP Port:8554

RTSP stream url :

rtsp:// admin:[ONVIF password]@[device IP address]:8554/Streaming/Channels/101

sample: rtsp://admin:1234@10.5.8.136:8554/Streaming/Channels/101

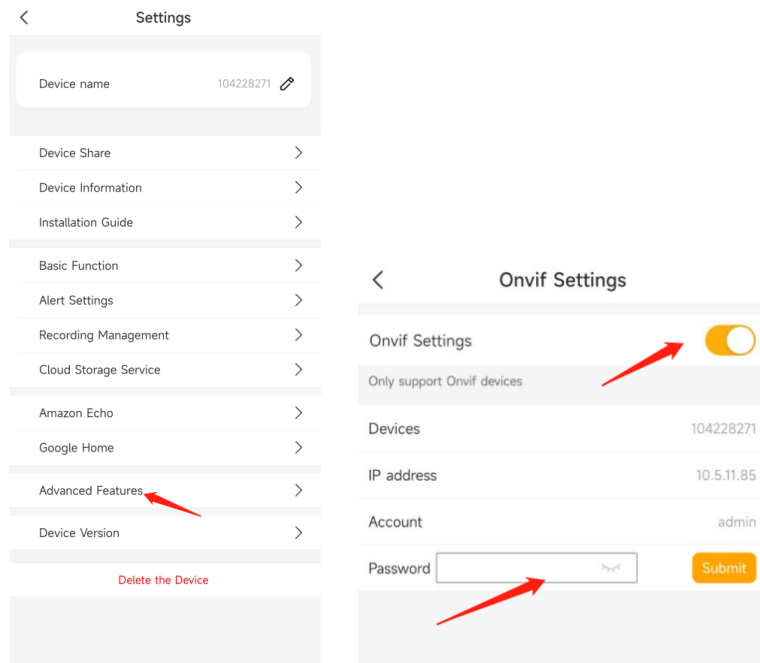

Device version

You can check the camera firmware whether need to be upgraded.

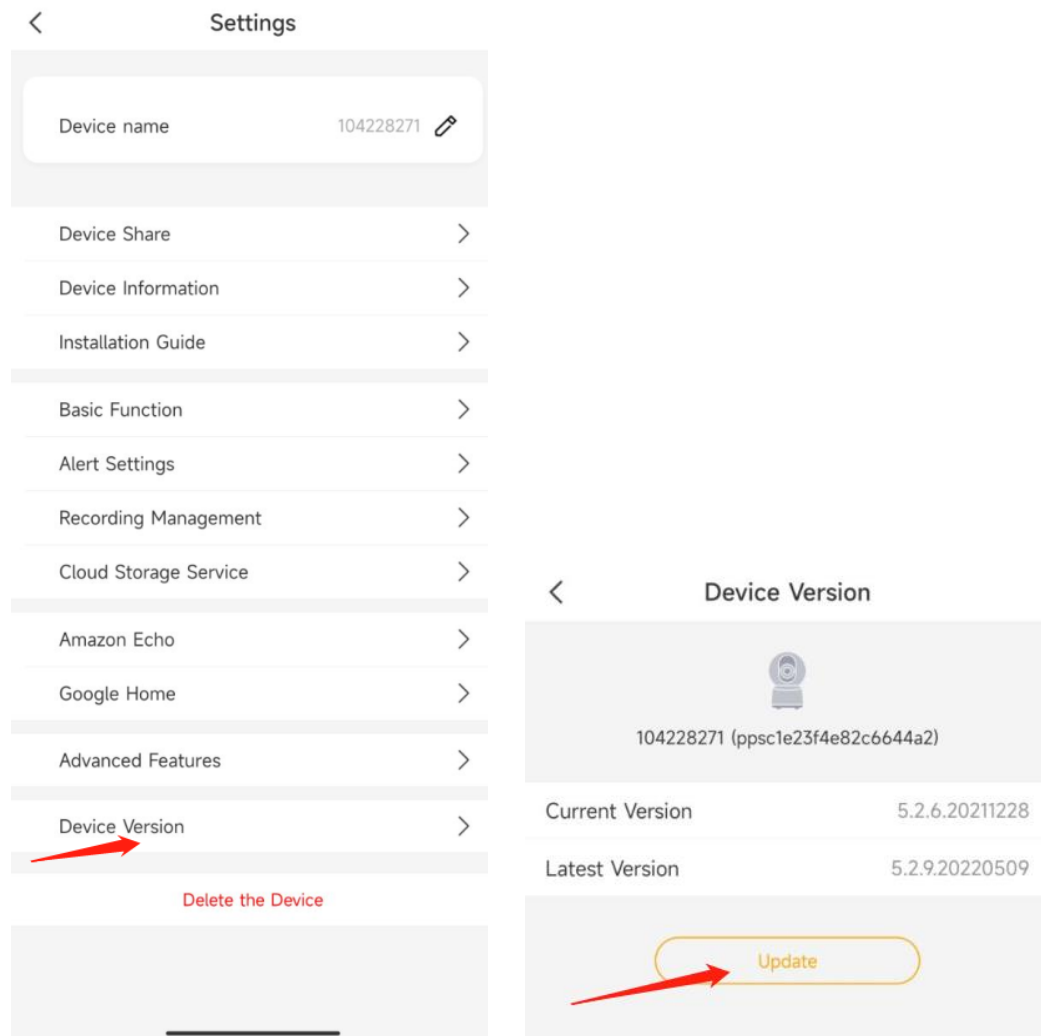

If have new firmware to be upgraded, you can tap 'upgrade' to upgrade the camera firmware.

Note: Whole upgrading process may take 5min, Please do not power off the camera when upgrading, camera will download the firmware from server and upgrade the firmware. Suggest keep camera near the wifi router for the better network to download.

Delete the Device

Tap to delete the device from you account.

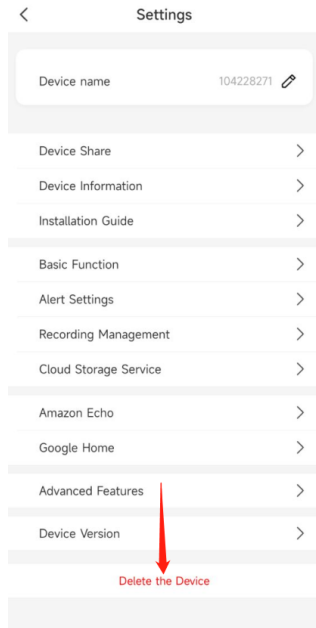

7. Use Arenti APP

Messages

Tap the Messages at the bottom.

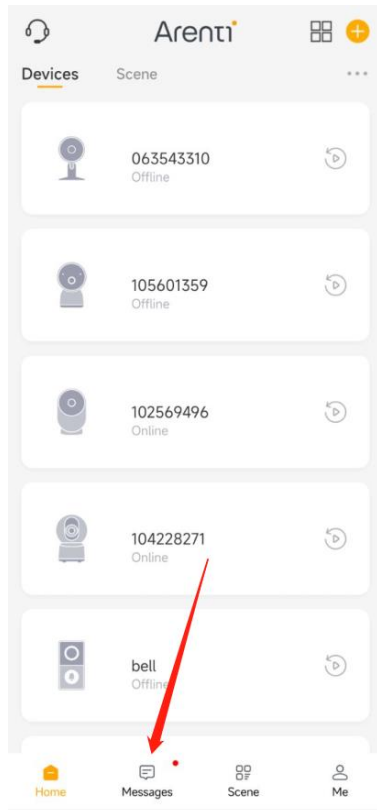

Sharing History

Tap Sharing History to check the sharing messages

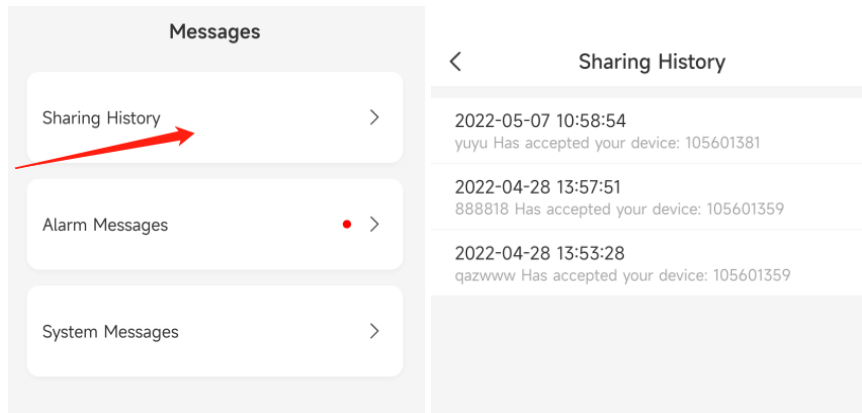

Alarm Message

Tap Alarm Messages-Device-check the Alarm message sent from camera

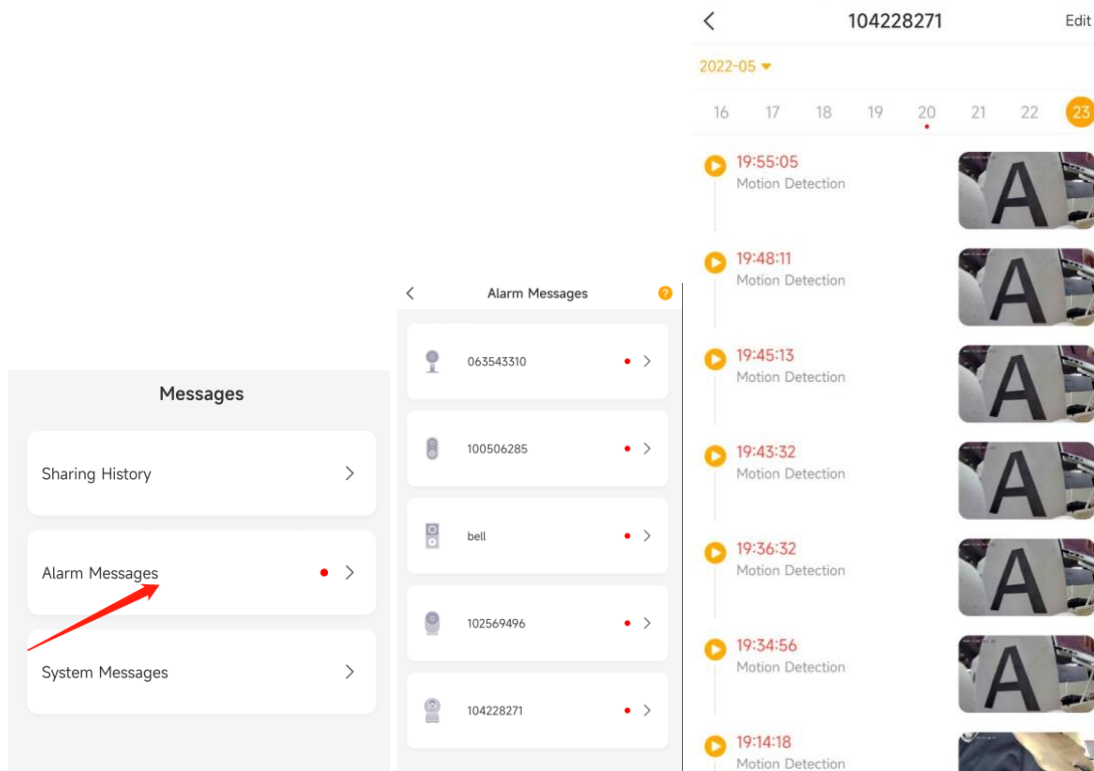

System Messages

Tap System Messages to check the battery low messages.

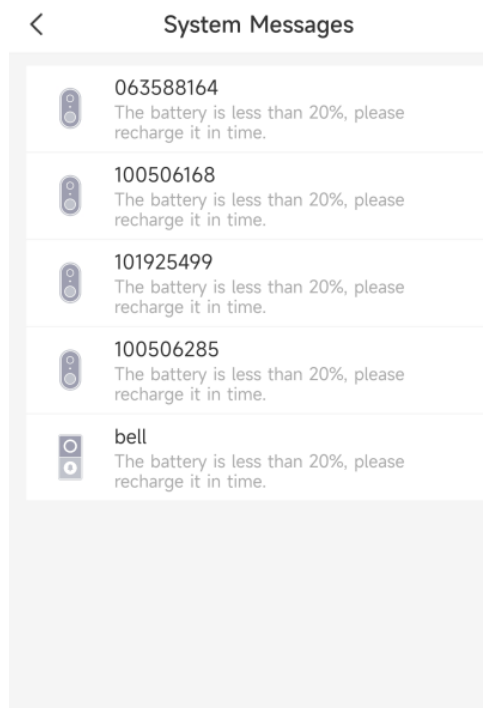
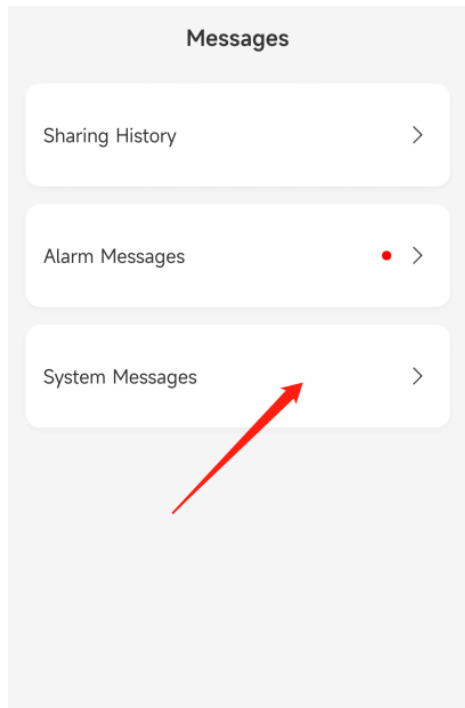

Scene

No device support now. Coming soon.

Account

Register (Sign up)

1. Open the Arenti App, click "Sign Up, Choose the country and input email address; enable the "User agreement and Privacy Policy" ,tap 'Next

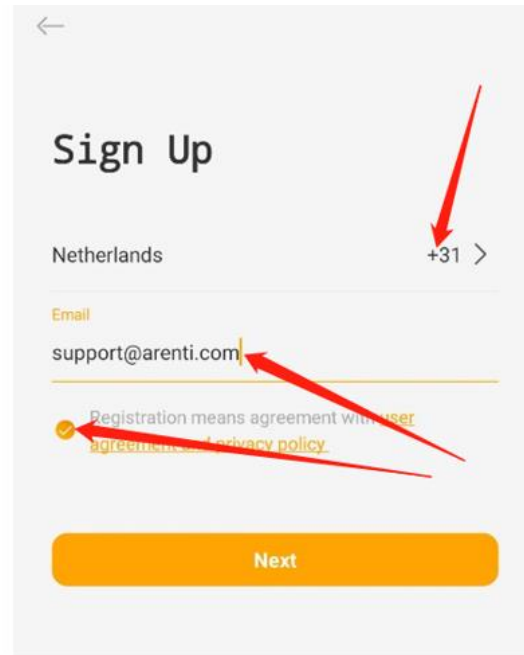
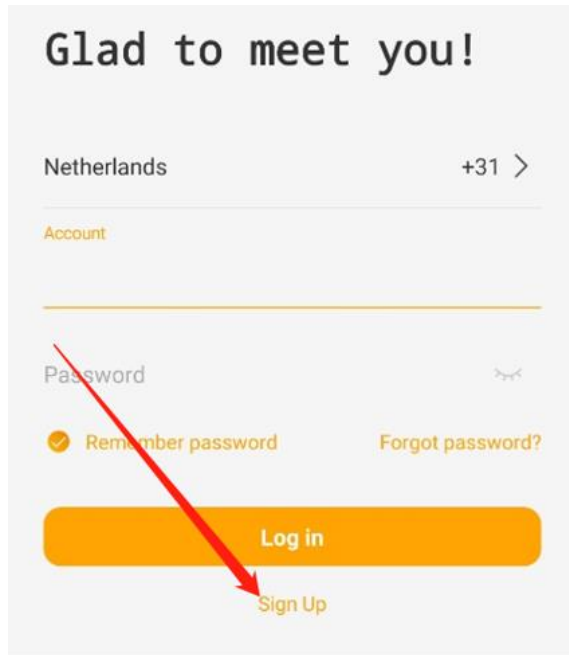

2. Set the Nickname and Password, tap 'Done'.

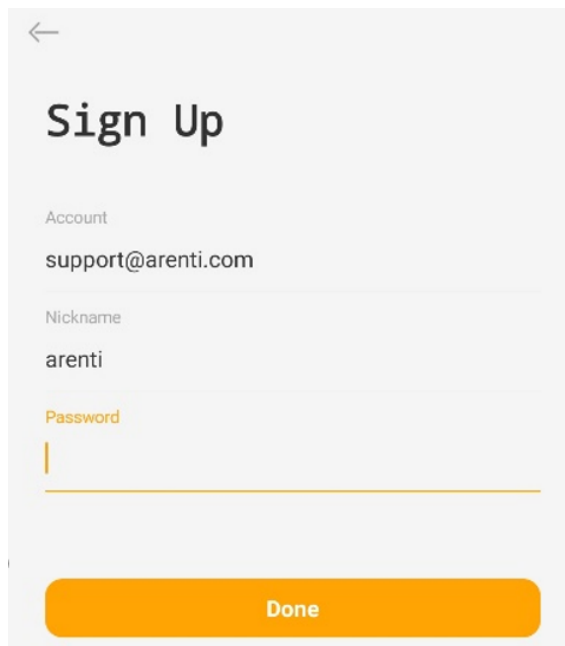

Reset Password

1. Tap the 'Forget password'
2. Input the correct Email address/Phone number, tap 'Next'
3. Input the verification code you received, and input the new password you want to set.
Done

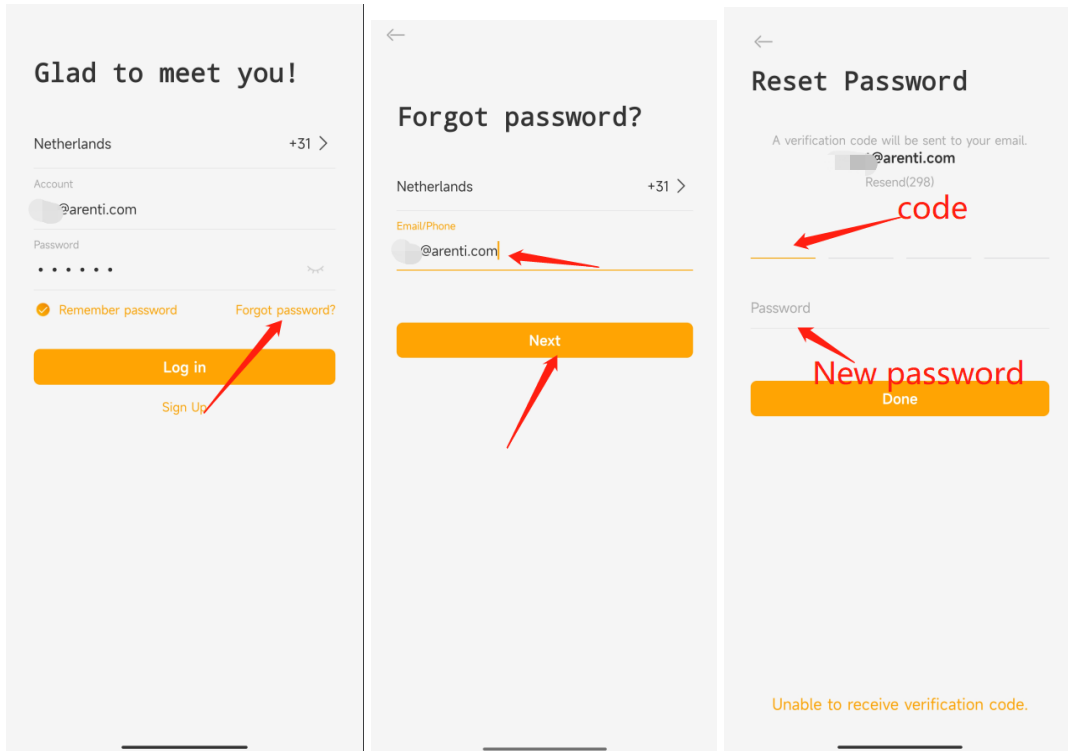

APP Settings

Launch APP tap Me-Settings:You can adjust the APP settings.

1. Pop up when receiving a message

After enable and APP is opened, a pop-up page will be displayed when an alarm message is received.

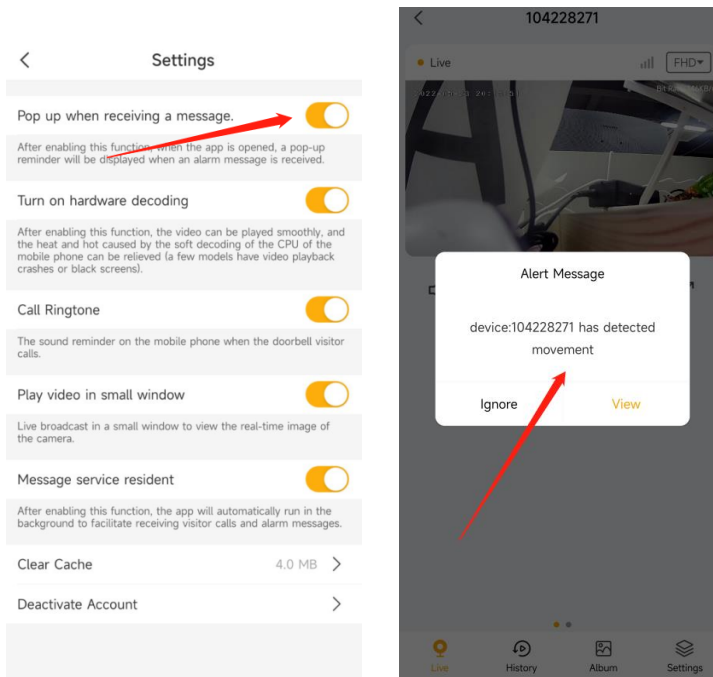

2. Turn on Hardware decoding
3. Call Ringtone
4. Play video in small window.

The window will possible always top, when you using other APP on mobile phone. You can keep watch the camera Live video.

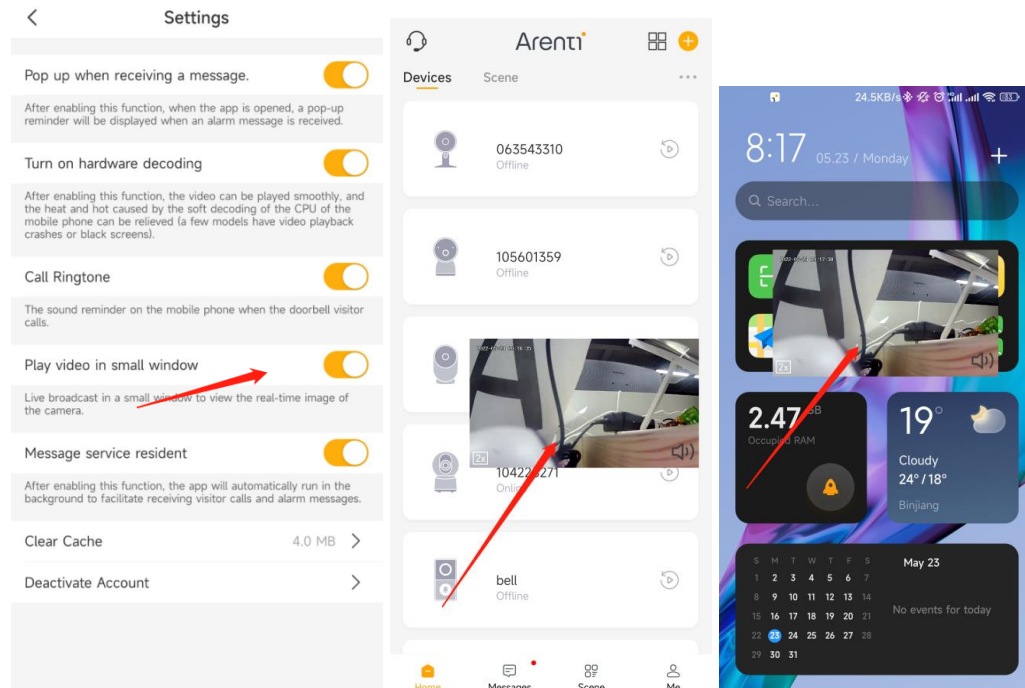

5. Message Service resident

Enable the 'Message Service resident', APP will run in the background to facilitate receiving visitor calls and Alarm messages.

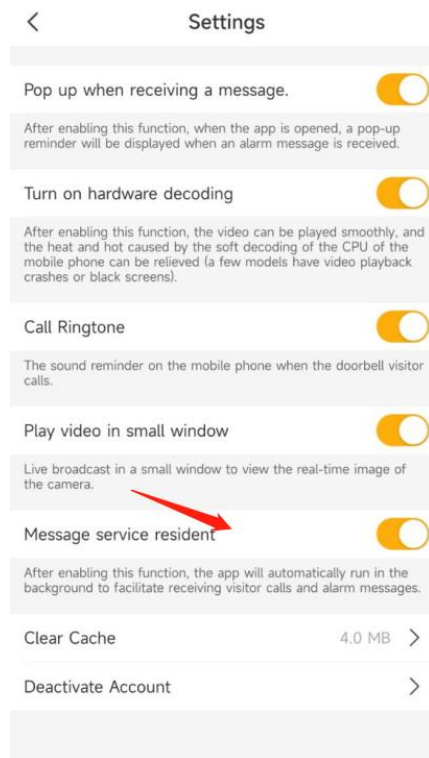

6. Clear Cache

Tap 'Clear Cache' - delete Alarm pictures/Temporary Files

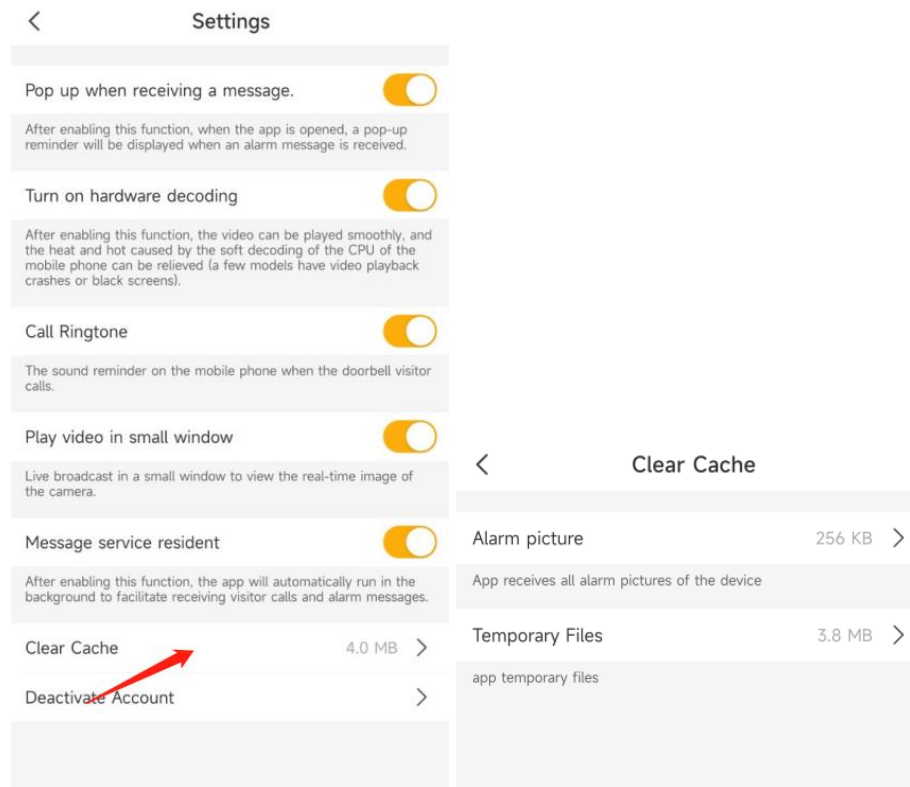

7. Deactivate Account

Tap to Deactivate Account

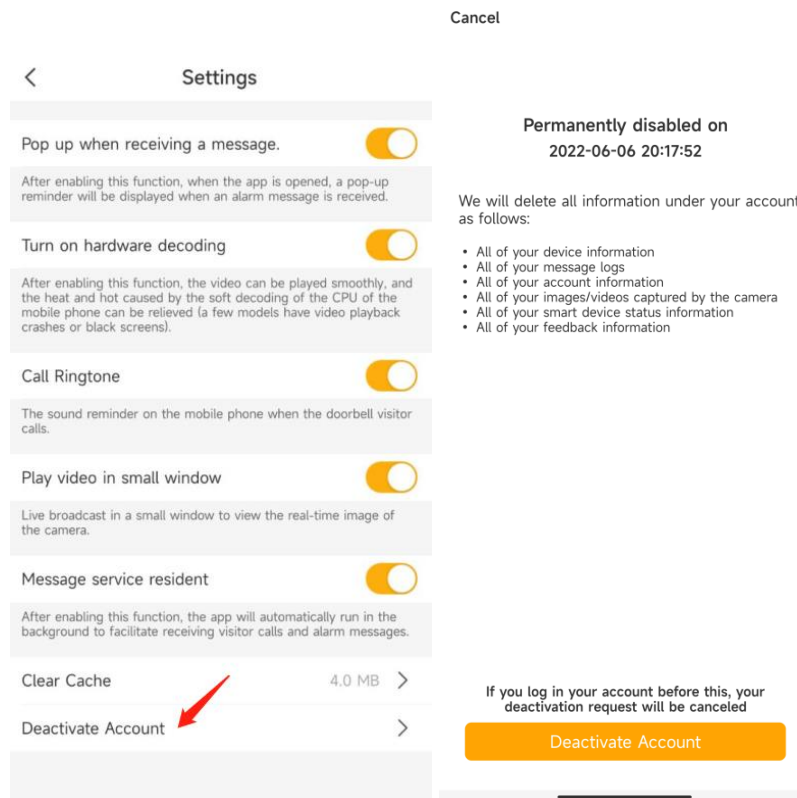

8. FAQ and Troubleshooting

FAQS

1. How to switch/change WiFi, update wifi password for device?

1. Delete the devices in your account in Arenti APP device list.(All recordings/subscription will be there, until you add it again)
2. Open APP click 'Add', and follow the steps use the new WIFI network to add the camera again.—Scan the qrcode when indicator is red flashing slowly.

2. What to do if I can't receive alert push notification?

1. Please ensure the Motion/Noise Detection: Arenti APP-Device(Tap device to live video page)-Settings-Alert settings, and Receive Alert Notification is enabled: Arenti APP-Device(Tap device to live video page)-Settings.
2. Please ensure the Message service resident (Arenti APP-Me-Settings) is enabled. The APP will Automatically run in the background to facilitate receiving visitor calls and alarm messages.
3. Please ensure notification for Arenti app has been enabled in phone setting. enter the phone system settings-notifications-find "Arenti" and enable notification permissions.
4. If you are using Android mobile phone, if you kill the APP, it will stop to receive the notification. Please confirm the APP is running there

3. Whether support viewing the SD card video via the computer?

Yes, It is supported.

1. Using the Micro SD card reader. Let the computer read the SD card.
2. You will find the video file in the SD card. It is an MP4 file, you could open and view the video on the computer directly.

4. How to delete /erase the video record in Micro-SD Card and Cloud storage?

SD card record: need you format the SD card and delete all recordings:APP-Device(tap to live video page)-Settings-Recording Management-Format SD card. Also you can use the SD card reader to connect the Micro-SD card with your computer, choose the file and delete it.

Cloud video record: it will be overwriting/deleted automatically after 3/7/30days depends on which service you subscribed. We have 3/7/30days looping cloud storage service.

5. Why the night vision image has a big reflection on window/glass?

When night vision is on, the infrared light will turn on also--to get clear image in the night. It will be very clear in the open area. If faced the glass, the infrared light will reflect off the glass, making bad image in night. If want to face the glass in the night, suggest turn off Night vision.

Troubleshooting

1. **Recognized the QR code successfully, but device fails to setup, and camera indicator shows red fast flashing:**

Your steps are all correct, maybe has some compatible issue with the wifi router.

1. Please try to confirm: wifi is 2.4GHz, not WPA3 security mode., password is correct, not contain special characters such as \';

2. Please put your device next to the router when set up. If this still does not work, please reboot your router (unplug for 10 minutes and plug in again) and reset your device to try again. Also, you can try to use another mobile/laptop as a hotspot to set up your device to test if it works with hotspot Wi-Fi. If it does not work with the hotspot, please connect us.

2. **Why my camera always offline/ lose connection?**

Network problems may cause the camera off-line. Solution:

- a) Check whether the power of the camera is sufficient.
- b) It is recommended that the wifi signal strength to be above 75%. Check from APP-Device (tap device to live video page)-Settings-Device information
- c) Restart the camera and router.
- d) Place the camera next to the router and observe whether the video is smooth. If the camera is still offline, it may be due to the camera hardware failure, please contact customer service

3. **My camera not working, after powering on/plug in ,there is no indicator light on.**

Please try to use the other adapter/cable and check again, if keep no light on, please send the camera SN and order number to support@arenti.com

4. **Why does the video always with the circle/buffering?**

The circle means that the video is loading, and the buffer and delay means that the network is not smooth. Please check whether the network connected between the camera and the mobile phone is smooth. It is recommended to place the camera close to the WIFI router.

5. **I already inserted the Micro SD Card Why APP keep shows "No SD card"?**

It means that the SD card identification fails or broken. Suggestions:

- a) Please use a brand SD card, high speed(Class 10 and above).
- b) The SD card can be identified by the computer normally.
- c) Only FAT32 format is supported. capacity between 2G-128G.
- d) It is recommended to try another SD card.

It may take some time for the camera to identify the SD card. After inserting the card, wait for about 30S and then observe.

6. **I got the alarm notifications, tap to check the video but failed to play.**

Please check it few mins later. Because the video may still in uploading to the cloud storage/Saving to SD card.